

PRESSURE SWITCHES



- Low to high pressure switch models with 2 psi to 7500 psi set points
- High-quality snap-action design
- Long-life elastomer diaphragms
- Proven sealed piston sensor on high-pressure models
- Over one million operating cycles
- 100% tested for accuracy
- Models for both pneumatic and hydraulic applications
- Adjustable and factory preset models
- Customizable
- NEMA 4 and 13 available

TABLE OF CONTENTS

8

PRESSURE SWITCHES



9	SQ	Low Pressure Switch
10	SM	Low Pressure Switch
11	MM	Low Pressure Switch
12	LM	Low Pressure Switch
13	CJ	Low Pressure Switch
14	XM	High Pressure Switch
15	WX	High Pressure Switch
16	CD	High Pressure Switch
17	CF	High Pressure Switch (Fixed Set Point)

*

RESOURCES

7	Basic Electrical Connection Options
58	Diaphragm Compatibility
59	Conversion Tables
60	Glossary of Terms

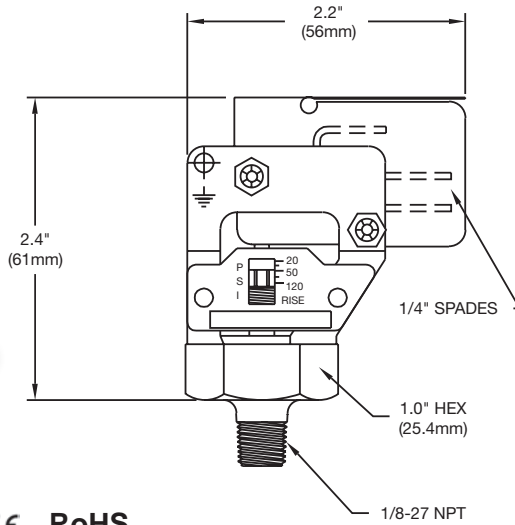
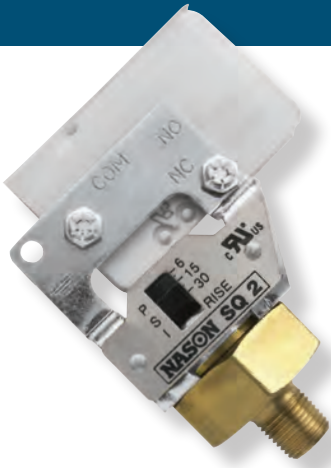

Features

- Long-life elastomer diaphragm
- High-quality snap-action switch
- Fingertip adjustment
- Visual calibration
- Economical
- Quick delivery

Operating Specifications

Set Point Range	2 — 120 PSI	(.14 — 8.3 Bar)
Set Point Tolerance	±1 PSI or 5%	(.07 Bar)
Maximum Operating Pressure	250 PSI	(17 Bar)
Proof Pressure	750 PSI	(51 Bar)
Differential	10 — 20%	
Current Rating	10 A @ 125/250 VAC	5 A @ 30 VDC
Media Connection	1/8" NPT Male Brass	
Circuit Form	SPDT	
Electrical Connection	1/4" Blades	
Diaphragm Material	Buna N	
Cycle Life	1 Million	
Operating Temperature	-20°F - +220°F	
Unit Weight	.2 lbs	

In-Stock Low Pressure Switches



Model	SQ-1	SQ-2	SQ-3
Adjustment Range	2 — 10 PSI	6 — 30 PSI	20 — 120 PSI

For more [media connections](#), see pages 23-24.
 For more [electrical connections](#), see page 7.



Shown with HP electrical option

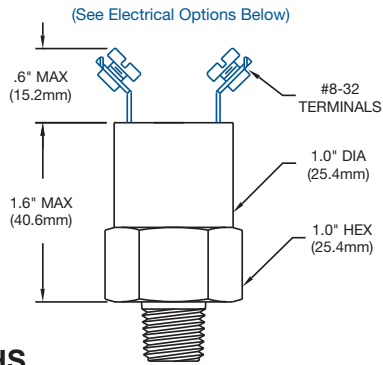

UL **CE** **RoHS**

Features

- Long-life elastomer diaphragm
- High-quality snap-action switch
- Factory preset
- Available in a wide range of configurations
- Economical
- Pneumatic and hydraulic applications
- NEMA 4, 13

Operating Specifications

Set Point Range	2 — 120 PSI	(.14 — 8.3 Bar)
Set Point Tolerance	±1 PSI or 5%	(.07 Bar)
Maximum Operating Pressure	250 PSI	(17 Bar)
Proof Pressure	750 PSI	(51 Bar)
Differential	8 — 16%	
Current Rating	5 A @ 250 VAC	5 A @ 30 VDC (Resistive)
Media Connection	Standard: Brass (Optional: Aluminum, Nickel Plating, Delrin, Zinc Plated Steel, 303 SS, 316 SS)	
Circuit Form	SPST-NO, SPST-NC or SPDT	
Electrical Connection	See Order Chart Below for Options	
Diaphragm Material	Buna N	
Cycle Life	1 Million	
Operating Temperature	-20°F - +220°F	
Unit Weight	.13 lbs	

CHECK OUT
nasonptc.com/configure
 to create your own custom CAD file

How to Order (Example: Part Number: **SM - 2A - 95R /**)

SM	-	2	A	-	9	5	R	/	*
Media Connection		Circuit Form		Fixed Set Point		Set Point Direction		Electrical Options	
1	1/4" NPT Male	A	SPST-NO	2 — 120 PSI		R	Rising	WL	Wire Leads 18"
2	1/8" NPT Male	B	SPST-NC			F	Falling	QC	1/4" Spade Connection
6	7/16" SAE O-Ring (-4)	C	SPDT					WP	Weather Pack
14	1/2" NPT Male 1/8" NPT Female							HR	DIN43650A Connector
17	1/4" BSPP Male (G1/4)							MP	Metri-Pack
28	1/8" BSPP Male (G1/8)							AT	10 A @ 125/250 VAC 5 A @ 30 VDC
41	7/16" — 20 Internal 45° Flare — SAE J 513							GG	Internal Ground
77	M16 x 1.5 SAE J2244-3							AU	Gold Plate/Alloy for low currents
								* Defaults to Screw Terminals	

For more **media connections**, see pages 23-24.

For all available **optional configurations**, see page 22.

For more **electrical connections**, see page 7.

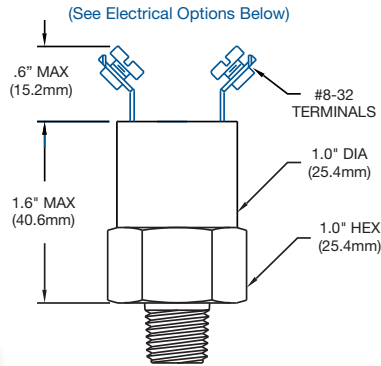

Shown with WP electrical option



Features

- Long-life elastomer diaphragm
- High-quality snap-action switch
- Factory preset
- Available in a wide range of configurations
- Economical
- Pneumatic and hydraulic applications
- NEMA 4, 13

Operating Specifications

Set Point Range	2 — 120 PSI	(.14 — 8.3 Bar)
Set Point Tolerance	±1 PSI or 5%	(.07 Bar)
Maximum Operating Pressure	600 PSI	(41 Bar)
Proof Pressure	1800 PSI	(124 Bar)
Differential	8 — 16%	
Current Rating	5 A @ 250 VAC	5 A @ 30 VDC (Resistive)
Media Connection	Standard: Brass (Optional: Aluminum, Nickel Plating, Delrin, Zinc Plated Steel, 303 SS, 316 SS)	
Circuit Form	SPST-NO, SPST-NC or SPDT	
Electrical Connection	See Order Chart Below for Options	
Diaphragm Material	Buna N	
Cycle Life	1 Million	
Operating Temperature	-20°F - +220°F	
Unit Weight	.16 lbs	

CHECK OUT
nasonptc.com/configure
 to create your own custom CAD file

How to Order (Example: Part Number: **MM - 6A - 80R / WL**)

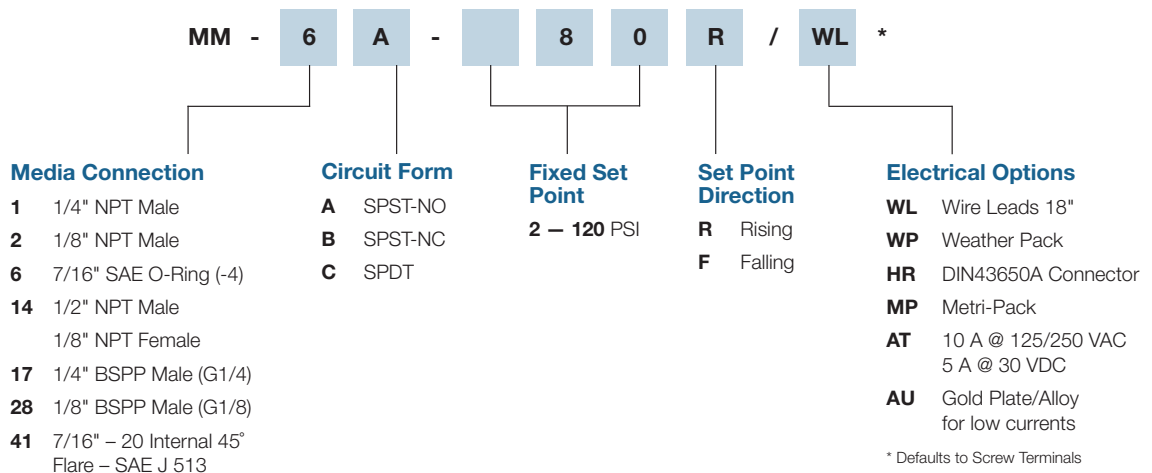

For more [media connections](#), see pages 23-24.

For all available [optional configurations](#), see page 22.

For more [electrical connections](#), see page 7.

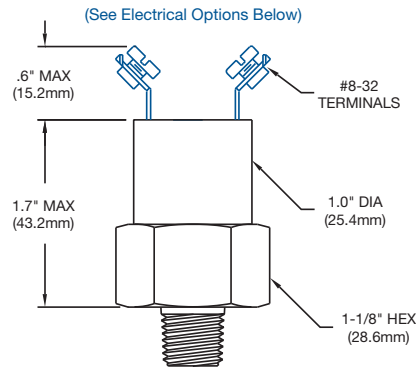

Shown with unibody housing and EF electrical option



Features

- Long-life elastomer diaphragm
- High-quality snap-action switch
- Factory preset
- Available in a wide range of configurations
- Economical
- Pneumatic and hydraulic applications
- NEMA 4, 13

Operating Specifications

Set Point Range	10 – 300 PSI	(.69 – 20 Bar)
Set Point Tolerance	±1 PSI or 5%	(.07 Bar)
Maximum Operating Pressure	2000 PSI	(137 Bar)
Proof Pressure	6000 PSI	(413 Bar)
Differential	12 – 24%	
Current Rating	5 A @ 250 VAC	5 A @ 30 VDC (Resistive)
Media Connection	Standard: Brass (Optional: Nickel Plating, Delrin, Zinc Plated Steel, 303 SS, 316 SS)	
Circuit Form	SPST-NO, SPST-NC or SPDT	
Electrical Connection	See Order Chart Below for Options	
Diaphragm Material	Buna N	
Cycle Life	1 Million	
Operating Temperature	-20°F - +220°F	
Unit Weight	.23 lbs	

CHECK OUT
nasonptc.com/configure
 to create your own custom CAD file

How to Order (Example: Part Number: **LM - 6A - 250R / WL**)

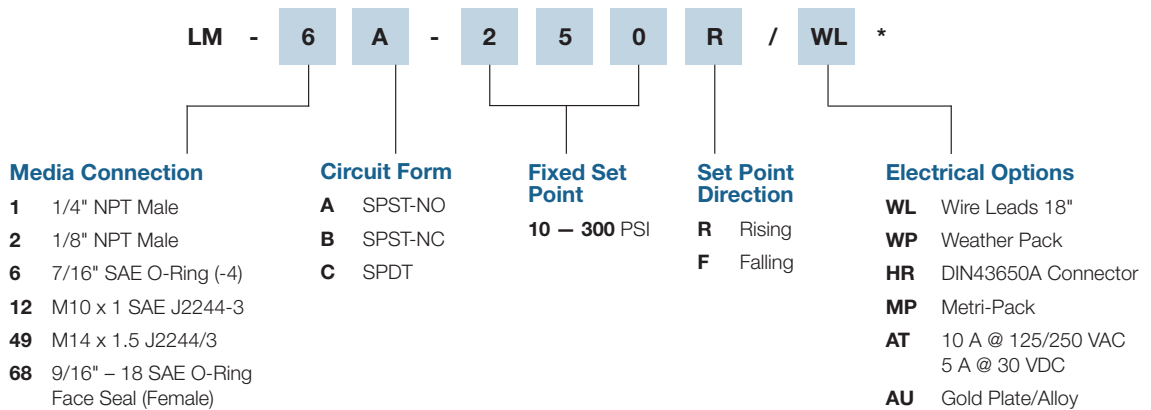

* Defaults to Screw Terminals

For more [media connections](#), see pages 23-24.

For all available [optional configurations](#), see page 22.

For more [electrical connections](#), see page 7.

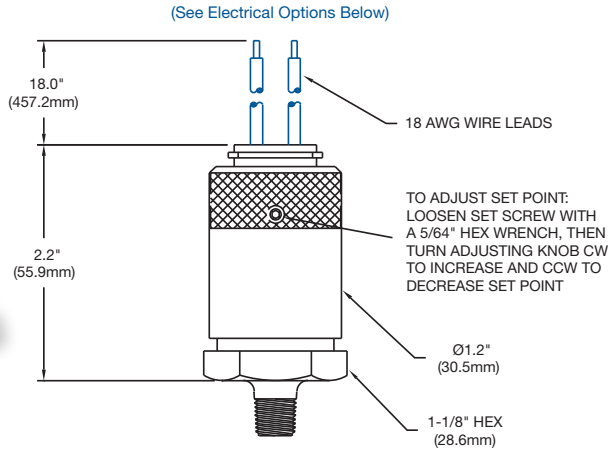

Shown with HM electrical option



Features

- Long-life elastomer diaphragm
- High-quality snap-action switch
- Field adjustable
- Compact design
- Easily customized
- Quick delivery
- NEMA 4, 13

Operating Specifications

Set Point Range	3 – 120 PSI	(.21 – 8.3 Bar)
Set Point Tolerance	±1 PSI or 5%	(.07 Bar)
Maximum Operating Pressure	250 PSI (Ranges 1 – 3)	(17 Bar)
Proof Pressure	750 PSI (Ranges 1 – 3)	(51 Bar)
Differential	10 – 20%	
Current Rating	3 A @ 125 VAC	2 A @ 30 VDC (Resistive)
Media Connection	Standard: Brass (Optional: Aluminum, Nickel Plating, Delrin, 303 SS, 316 SS)	
Circuit Form	SPST-NO, SPST-NC or SPDT	
Electrical Connection	See Order Chart Below for Options	
Diaphragm Material	Buna N	
Cycle Life	1 Million	
Operating Temperature	-20°F - +220°F	
Unit Weight	.42 lbs	

CHECK OUT
nasonptc.com/configure
 to create your own custom CAD file

How to Order (Example: Part Number: **CJ - 1B3 - 60J / WL**)

CJ -		1	B	3	-	6	0	J	/	WL
Media Connection	Circuit Form	Range		Desired Set Point		Set Point Direction		Electrical Options		
1 1/4" NPT Male	A SPST-NO	1 3 – 10 PSI	2 6 – 30 PSI	3 20 – 120 PSI	3 – 120 PSI	J Rising Adjustable	WL Wire Leads 18"	WP Weather Pack		
2 1/8" NPT Male	B SPST-NC	4* 100 – 400 PSI	5* 500 – 1500 PSI	*121 – 1500 PSI	G Falling Adjustable	HM 9.4mm DIN	MP Metri-Pack			
6 7/16" SAE O-Ring (-4)	C SPDT					AU Gold Plate/Alloy for low currents				
12 M10 x 1 SAE J2244-3										
17 1/4" BSPP Male										
28 1/8" BSPP Male										

* Not yet UL recognized

For more **media connections**, see pages 23-24.

For all available **optional configurations**, see page 22.

For more **electrical connections**, see page 7.

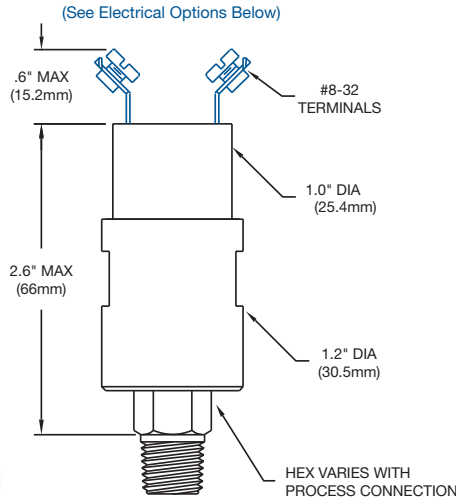

Shown with unibody housing and EL electrical option



Features

- Long-life elastomer diaphragm
- High-quality snap-action switch
- Factory preset
- Compact design
- Available in a wide range of configurations
- Proven in the most demanding mobile hydraulic applications
- NEMA 4, 13

Operating Specifications

Set Point Range	40 — 4000 PSI	(1.3 — 275 Bar)
Set Point Tolerance	±5 PSI or 5%	(.34 Bar)
Maximum Operating Pressure	5000 PSI	(344 Bar)
Proof Pressure	15000 PSI	(1034 Bar)
Differential	8 — 16%	
Current Rating	5 A @ 250 VAC	5 A @ 30 VDC (Resistive)
Media Connection	Standard: Zinc Plated Steel (<i>Optional: Brass, Nickel Plating, 303 SS, 316 SS</i>)	
Circuit Form	SPST-NO, SPST-NC or SPDT	
Electrical Connection	See Order Chart Below for Options	
Diaphragm Material	Buna N	
Cycle Life	1 Million	
Operating Temperature	-20°F - +220°F	
Unit Weight	.56 lbs	

CHECK OUT
nasonptc.com/configure
 to create your own custom CAD file

How to Order (Example: Part Number: **XM - 1A - 1500R / WL**)

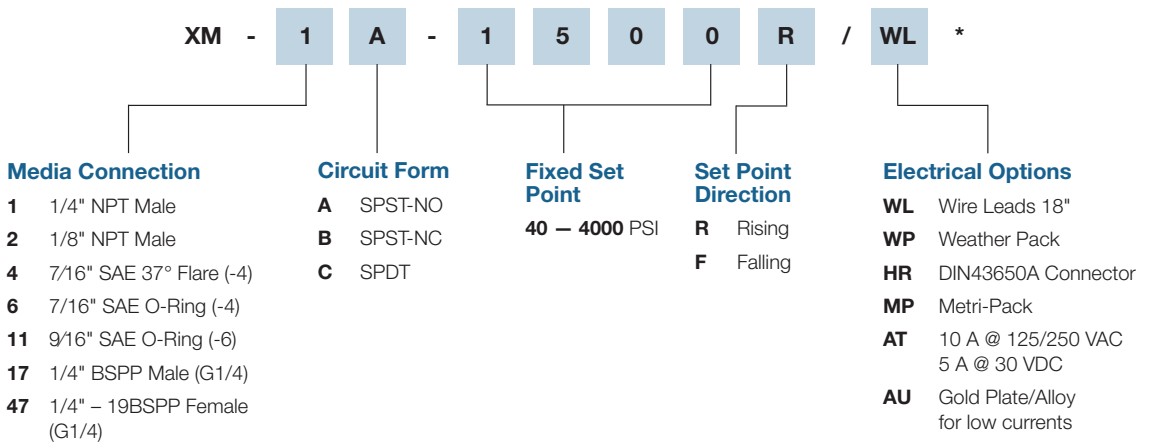

* Defaults to Screw Terminals

For more **media connections**, see pages 23-24.

For all available **optional configurations**, see page 22.

For more **electrical connections**, see page 7.

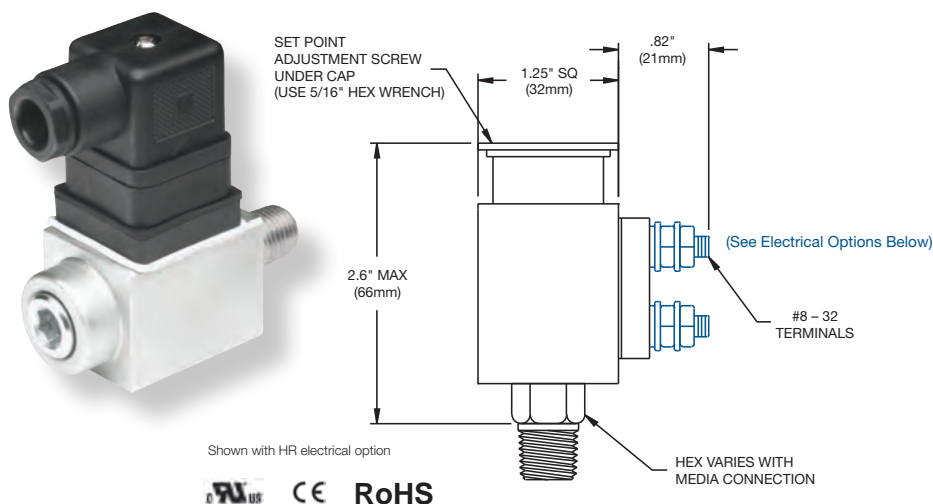

Features

- Long-life elastomer diaphragm
- High-quality snap-action switch
- Field adjustable
- Compact design
- Available in a wide range of configurations
- Proven in the most demanding mobile hydraulic applications
- NEMA 4, 13

Operating Specifications

Set Point Range	50 — 5000 PSI	(1.38 — 344 Bar)
Set Point Tolerance	±5 PSI or 5%	(.34 Bar)
Maximum Operating Pressure	5000 PSI	(344 Bar)
Proof Pressure	15000 PSI	(1034 Bar)
Differential	3 — 10%	
Current Rating	5 A @ 250 VAC	5 A @ 30 VDC (Resistive)
Media Connection	Standard: Zinc Plated Steel (<i>Optional: Brass, Nickel Plating, 303 SS, 316 SS</i>)	
Circuit Form	SPST-NO, SPST-NC or SPDT	
Electrical Connection	See Order Chart Below for Options	
Diaphragm Material	Buna N	
Cycle Life	1 Million	
Operating Temperature	-20°F - +220°F	
Unit Weight	.80 lbs	

CHECK OUT
nasonptc.com/configure
 to create your own custom CAD file

How to Order (Example: Part Number: **WX - 2A - 100J / HR** *)

WX - 2 A - 1 0 0 J / HR *	2	A	1 0 0	J	HR
Media Connection 1 1/4" NPT Male 2 1/8" NPT Male 4 7/16" SAE 37° Flare (-4) 6 7/16" SAE O-Ring (-4) 11 9/16" SAE O-Ring (-6) 17 1/4" BSPP Male (G1/4) 39 1/4" - 18 NPTF SAE J516 (-4) 67 9/16" - 18 SAE O-Ring Face Seal	Circuit Form A SPST-NO B SPST-NC C SPDT	Adjustment Range 50 — 150 PSI 140 — 400 PSI 300 — 800 PSI 700 — 2500 PSI 2000 — 5000 PSI	Set Point Direction J Rising Adjustable G Falling Adjustable	Electrical Options WL Wire Leads 18" QC 1/4" Spade Connection WP Weather Pack HR DIN43650A Connector MP Metri-Pack AT 10 A @ 125/250 VAC 5 A @ 30 VDC GG Internal Ground AU Gold Plate/Alloy for low currents	

* Defaults to Screw Terminals

For more [media connections](#), see pages 23-24.

For all available [optional configurations](#), see page 22.

For more [electrical connections](#), see page 7.

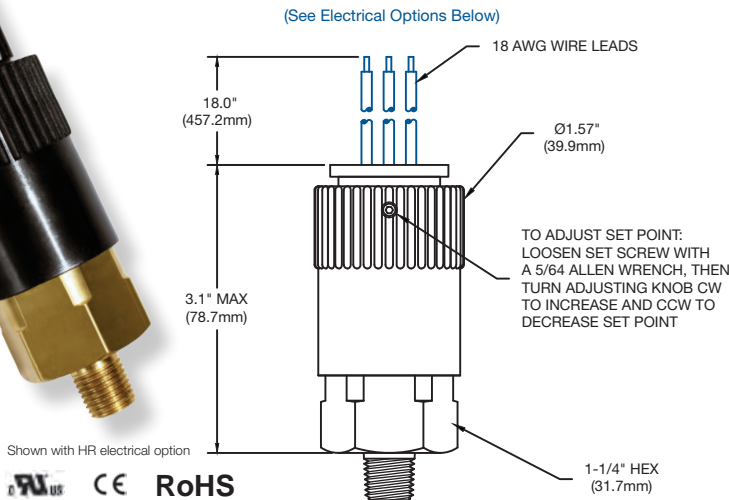

Features

- Long-life elastomer diaphragm (Ranges 1 – 3)
- Proven sealed piston sensor (Ranges 4 – 8)
- High-quality snap-action switch
- Field adjustable
- Easily customized
- Quick delivery
- NEMA 4, 13

Operating Specifications

Set Point Range	10 – 7500 PSI	(.69 – 517 Bar)
Set Point Tolerance	±5 PSI or 5%	(.34 Bar)
Maximum Operating Pressure	1000 PSI (Ranges 1 – 3)	(69 Bar)
	5000 PSI (Ranges 4 – 7)	(344 Bar)
	7500 PSI (Range 8)	(517 Bar)
Proof Pressure	3000 PSI (Ranges 1 – 3)	(206 Bar)
	15000 PSI (Ranges 4 – 7)	(1034 Bar)
	22500 PSI (Range 8)	(1551 Bar)
Differential	10 – 20%	
Current Rating	5 A @ 250 VAC	5 A @ 30 VDC (Resistive)
Media Connection	Standard: Brass (Optional: Nickel Plating, 303 SS, 316 SS)	
Circuit Form	SPST-NO, SPST-NC or SPDT	
Electrical Connection	See Order Chart Below for Options	
Diaphragm Material	Buna (Ranges 1 – 3) Hardened Steel Piston (Ranges 4 – 8)	
Cycle Life	1 Million	
Operating Temperature	-20°F - +220°F	
Unit Weight	.47 lbs (noryl adjustment knob); .70 lbs (metal adjustment knob)	

CHECK OUT
nasonptc.com/configure
 to create your own custom CAD file

How to Order (Example: Part Number: **CD - 1B5 - 750 J / EL**)

CD	-	1	B	5	-	7	5	0	J	/	EL
Media Connection		Circuit Form		Range		Desired Set Point		Set Point Direction		Electrical Options	
Piston		A SPST-NO		1 10 – 40 PSI		10 – 7500 PSI		J Rising Adjustable		WL Wire Leads 18"	
1 1/4" NPT Male		B SPST-NC		2 25 – 100 PSI				G Falling Adjustable		EL Male Conduit 1/2" – 14	
3 3/4" SAE Male (-8)		C SPDT		3 50 – 200 PSI						EF Female Conduit 1/2" – 14	
11 9/16" SAE Male				4 100 – 400 PSI						HR DIN43650A Connector	
Diaphragms				5 250 – 1000 PSI						HH DIN43650A Plug Only	
1 1/4" NPT Male				6 500 – 2000 PSI						WP Weather Pack	
9 3/8" NPT Male				7 1200 – 4500 PSI						MP Metri-Pack	
				8 2400 – 7500 PSI						WD Deutsch	
										AT 10 A @ 125/250 VAC 5 A @ 30 VDC	
										AU Gold Plate/Alloy for low currents	

For more **media connections**, see pages 23-24.

For all available **optional configurations**, see page 22.

For more **electrical connections**, see page 7.

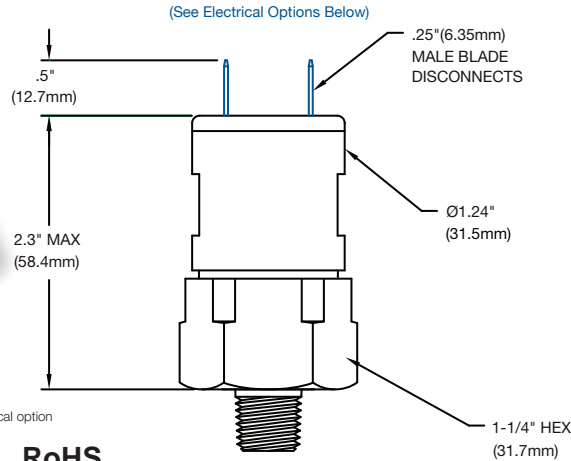

Shown with ES electrical option

UL **CE** **RoHS**

Features

- Long-life elastomer diaphragm (Set Points: 10 – 300 PSI)
- Proven sealed piston sensor (Set Points: 100 – 4500 PSI)
- High-quality snap-action switch
- Easily customized
- Quick delivery
- NEMA 4, 13

Operating Specifications

Set Point Range	10 – 4500 PSI	(.69 – 310 Bar)
Set Point Tolerance	±5 PSI or 5%	(.34 Bar)
Maximum Operating Pressure	1000 PSI (Diaphragm Model)	(69 Bar)
	5000 PSI (Piston Model)	(344 Bar)
Proof Pressure	3000 PSI (Diaphragm Model)	(206 Bar)
	15000 PSI (Piston Model)	(1034 Bar)
Differential	10 – 20%	
Current Rating	5 A @ 250 VAC	5 A @ 30 VDC (Resistive)
Media Connection	Standard: Brass (Optional: Nickel Plating, 303 SS, 316 SS)	
Circuit Form	SPST-NO, SPST-NC or SPDT	
Electrical Connection	See Order Chart Below for Options	
Diaphragm Material	Buna (Diaphragm Design) Hardened Steel Piston (Piston Design)	
Cycle Life	1 Million	
Operating Temperature	-20°F - +220°F	
Unit Weight	.33 lbs (noryl switch housing); .38 lbs (metal switch housing)	

CHECK OUT
nasonptc.com/configure
to create your own custom CAD file

How to Order (Example: Part Number: **CF - 1B - 750R / EL**)

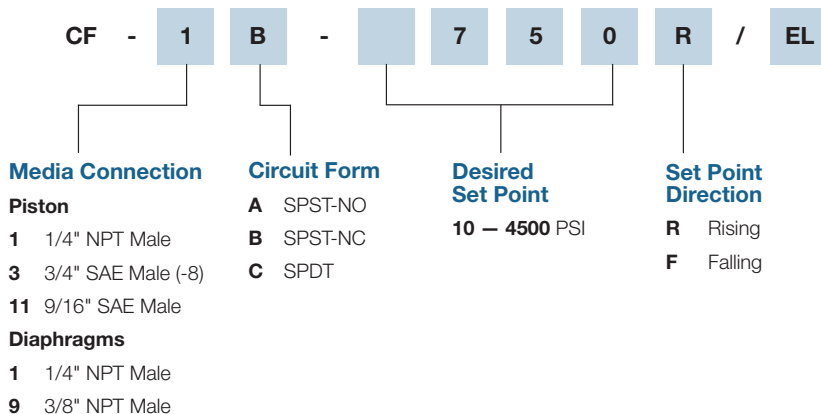

Electrical Options

- WL** Wire Leads 18"
- EL** Male Conduit 1/2" – 14
- EF** Female Conduit 1/2" – 14
- HR** DIN43650A Connector
- HH** DIN43650A Plug Only
- WP** Weather Pack
- MP** Metri-Pack
- WD** Deutsch
- AT** 10 A @ 125/250 VAC
5 A @ 30 VDC
- AU** Gold Plate/Alloy for low currents

For more [media connections](#), see pages 23-24.

For all available [optional configurations](#), see page 22.

For more [electrical connections](#), see page 7.

ELECTRICAL CONNECTION OPTIONS

MORE THAN THE COMPETITION

Nason knows that your designs are used in all types of applications imaginable, so we want to make sure you have a choice of how you configure electrical connections. We offer you a wide and growing selection of connections, and if you want something else, just ask our design engineers for it.



Screw
Terminals
#8 – 32



HF

HH

HR

HP

HM

MP

NP

DIN43650A
1/2" Conduit
(Plug & Receptacle)
IP65

DIN43650A
(Plug Only)

DIN43650A
Strain Relief
(Plug & Receptacle)
IP67

9.4mm
DIN
(Plug Only)

9.4mm DIN
(Plug & Receptacle)
IP65

Metri-Pack
Female 280
Series Sealed
IP66

Metri-Pack
Male 280
Series Sealed
IP66



CP

DP

PP

QC

WL

WP

TP

Metri-Pack
Female 150
Series Sealed
IP66

Metri-Pack
Male 150
Series Sealed
IP66

Boot
(Military Connector)

1/4" Male
Spade Quick
Connect

Wire Leads

Weather Pack
(Female)
IP66

Weather
Pack
(Male)
IP66



EL

EF

WD

PD

ES

CL

SL

VL

1/2" NPT
Male
Conduit

1/2" NPT
Female
Conduit

Deutsch
Receptacle
IP67

Deutsch
Plug
IP67

M12 - 4PIN
IP67

Sheathed
18 AWG
Primaries

SJO
Cable

Convolute
Covering

Color Code:
Pin Assignments:
DIN Connector Pin Assignments:
M12 Connector Pin Assignments:

Black – Common
A – Normally Open
#1 – Common
#1 – Common

Red – Normally Open
B – Common
#2 – Normally Closed
#2 – Not Used

Blue – Normally Closed
C – Normally Closed
#3 – Normally Open
#3 – Normally Open

#4 – Not Used
#4 – Normally Closed

Diaphragm Compatibility

Media	Buna	EP	Viton
Acetic Acid		•	
Acetone		•	
Acetylene	•		
Air	•		
Alcohols	•		
Alkalies (Weak)	•		
Alkalies (Strong)		•	
Ammonia (Anhydrous)	•		
Ammonia (Hydroxide)		•	
Asphalt			•
Automotive Oils	•		
Beer	•		
Benzene			•
Boric Acid	•		
Brake Fluid		•	
Bunker Oil	•		
Butane	•		
Butyl Cellosolve		•	
Carbon Dioxide	•		
Carbon Monoxide	•		
Cellube		•	
Chlorobenzene			•
Citric Acid	•		
Coke Oven Gas			•
Coolanol	•		
Diesel Fuels	•		
Di-Ester Lube (MIL-L-7808)			•
Dowtherm A&E		•	
Ethanol	•		
Ether		•	
Ethylene	•		
Ethylene Glycol	•		
Freon 11, 12, 112, 114	•		
Freon 22		•	
Fyrquel		•	
Fuel Oil	•		
Gasoline	•		
Glycerin	•		
Helium	•		
Hexane	•		

Media	Buna	EP	Viton
Hydraulic Oil (PET Base)	•		
Hydrocarbons	•		
Hydrogen	•		
Hydrogen Sulphide		•	
Isopropanol		•	
JP-3-6	•		
Kerosene	•		
LPG	•		
Lube Oil (PET base)	•		
Methanol	•		
MEK		•	
Mineral Oil	•		
Motor Oils	•		
Naptha		•	
Natural Gas	•		
Nitric Acid		•	
Nitrogen	•		
Oleum Spirits			•
Oxygen	•		
Ozone		•	
Crude Oil	•		
Phosphoric Acid			•
Propane	•		
Propanol	•		
Pydraul		•	
Shell Iris 902	•		
Silicone Greases	•		
Silicone Oils	•		
Skydrol 500 & 7000		•	
Soap Solutions	•		
Steam Below 320°F		•	
Stoddard Solvent	•		
Sulfuric Acid			•
Toluene			•
Transmission Fluid A	•		
Trisodium Phosphate	•		
Turpentine	•	•	
Water to 220°F (104°C)	•		
Water to 302°F (150°C)		•	

Other diaphragm materials are available. Consult factory for stock.

Temperature Conversions - [Formula °C = 5/9 (°F - 32°) °F = (9/5 °C) +32°]

°C	°F	°C	°F	°C	°F	°C	°F	°C	°F
40	104.0	62	143.6	84	183.2	106	222.8	128	262.4
41	105.8	63	145.4	85	185.0	107	224.6	129	264.2
42	107.6	64	147.2	86	186.8	108	226.4	130	266.0
43	109.4	65	149.0	87	188.6	109	228.2	131	267.8
44	111.2	66	150.8	88	190.4	110	230.0	132	269.6
45	113.0	67	152.6	89	192.2	111	231.8	133	271.4
46	114.8	68	154.4	90	194.0	112	233.6	134	273.2
47	116.6	69	156.2	91	195.8	113	235.4	135	275.0
48	118.4	70	158.0	92	197.6	114	237.2	136	276.8
49	120.2	71	159.8	93	199.4	115	239.0	137	278.6
50	122.0	72	161.6	94	201.2	116	240.8	138	280.4
51	123.8	73	163.4	95	203.0	117	242.6	139	282.2
52	125.6	74	165.2	96	204.8	118	244.4	140	284.0
53	127.4	75	167.0	97	206.6	119	246.2	141	285.8
54	129.2	76	168.8	98	208.4	120	248.0	142	287.6
55	131.0	77	170.6	99	210.2	121	249.8	143	289.4
56	132.8	78	172.4	100	212.0	122	251.6	144	291.2
57	134.6	79	174.2	101	213.8	123	253.4	145	293.0
58	136.4	80	176.0	102	215.6	124	255.2	146	294.8
59	138.2	81	177.8	103	217.4	125	257.0	147	296.6
60	140.0	82	179.6	104	219.2	126	258.8	148	298.4
61	141.8	83	181.4	105	221.0	127	260.6	149	300.2

Pressure Conversion Formulas

Into > Multiply by To Convert	PSI	H2O (15°C)	mmHg (0°C)	"Hg (0°C)	Millibar	Bar	Kg/Cm2	kPa
PSI	•	27.70	51.71	2.036	68.95	0.06895	0.07031	6.895
"H2O (15°C)	0.03609	•	1.867	0.07349	2.489	0.002489	0.002538	0.249
mmHg (0°C)	0.01934	0.5357	•	0.03937	1.3333	0.0013333	0.0013596	0.113
"Hg (0°C)	0.4912	13.61	25.40	•	33.86	0.03386	0.03453	3.386
Millibar	0.0145	0.4018	0.750062	0.02953	•	0.001	0.0010197	0.09998
Bar	14.50	401.8	750.062	29.53	1000	•	1.0197	99.98
Kg/Cm2	14.22	394.05	735.559	28.96	980.7	0.9807	•	98.05
kPa	0.145	4.016	7.519	0.2953	10.002	0.010	0.0102	•

Glossary of Terms

Snap-Action Switches

Nason uses only the highest quality snap-action electrical switches which insures a positive, instantaneous electrical contact under all operating conditions. Nason electrical switches are UL, CSA, CE, and military listed. Ask about our new environmentally sealed snap-action switch.

Diaphragms

Nason pressure switches incorporate elastomer diaphragms to provide a positive media seal. Nitrile is the material of choice for most applications. Ethylene propylene, fluorocarbon, fluorosilicon, and neoprene are readily available for specific applications.

Differential

A distinct change in pressure (or temperature for temperature switches) is necessary to reset a Nason snap-action switch to its original electrical state. This feature prevents “searching” and maximizes switch and system life. Catalog ranges are typical mid-range and can be varied with special construction.

Electrical Connections

A wide variety of electrical connectors are readily available for most applications. Screw terminals, wire leads, blades, studs, conduit, automotive DIN and military connectors are stock items.

Media Connections

Nason’s offering of media connections is unmatched in the industry. NPT, BSP, SAE, JIS, DIN, MS and many others are readily available.

Electrical Circuits

A unique variety of electrical contact arrangements allows the system designer to achieve complex logic at minimal cost. Contact arrangements up to form ZZ and isolated dual set points are available.

Electrical Rating

Most Nason switches are available in a nominal 5 or 10 AMP rating. Gold plated contacts for low current and 25 AMP ratings are also available.

Life

The operational life of a Nason switch is normally in excess of one million cycles. Operating life depends on many variables, and specific tests should be run if marginal conditions exist.

Application

Nason switches are used successfully in a great variety of pneumatic and hydraulic applications. Military vehicles and equipment, aviation, marine, machine tools, farm and construction equipment, process equipment, medical equipment, and industrial machinery are typical applications.

Customization

Nason has the experience and willingness to customize any switch to meet specific application requirements. Special media connections, electrical connections, circuitry and construction materials can be designed and produced as needed.

Installation Torques

Pressure Switch - 10 ft lbs
 Temperature Switch - 14-15 ft lbs.

Circuitry

Adjustable Pressure Switch
 Component Symbol

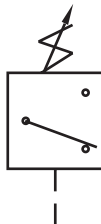

Fixed Pressure Switch
 Component Symbol

