

GRUNDFOS DOSING ALL PRODUCT



2 • GRUNDFOS

IT IS OUR MISSION – the basis of our existence – to successfully develop, produce, and sell high quality pumps and pumping systems worldwide, contributing to a better quality of life and a healthier environment.

A GLOBAL BUSINESS

With almost 18,000 employees worldwide, and annual production of 16 million pump units per year, Grundfos is one of the world's leading pump manufacturers. The 80 Grundfos Companies around the globe help bring pumps to every corner of the world, supplying drinking water to Antarctic expeditions, irrigating Dutch tulips, monitoring groundwater beneath waste heaps in Germany, and air conditioning Egyptian hotels.

Efficient, sustainable products

Grundfos is constantly striving to make its products more user-friendly and reliable as well as energy-saving and efficient. Our pumps are equipped with ultra-modern electronics allowing output to be regulated according to current needs. This ensures convenience for the end-user, saves a great deal of energy and, in turn, benefits the environment.

Research and development

In order to maintain its market position, Grundfos takes customer research to heart when improving or developing new products. Our Research and Development department makes use of the latest technology within the pump industry in search of new and better solutions for the design and function of our pump solutions.

Corporate values

The Grundfos Group is based on values such as sustainability, openness, trustworthiness, responsibility, and also on partnership with clients, suppliers and the whole of society around us, with a focus on humanity that concerns our own employees as well as the many millions who benefit from water that is procured, utilized and removed as wastewater with the help of Grundfos pumps.



GRUNDFOS • 3

Technology and Business Development Center
at Group headquarters in Denmark

GRUNDFOS NORTH AMERICA

- › North American headquarters in Olathe, Kansas
- › Manufacturing in Fresno, California
- › Service, distribution and light assembly in Allentown, Pennsylvania
- › Sales and assembly located in Canada and Mexico
- › Grundfos CBS in Brookshire, Texas

Fresno, California



Olathe, Kansas

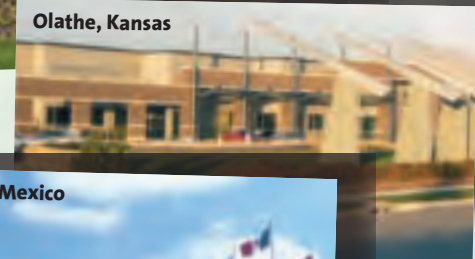

Monterrey, Mexico



Allentown, Pennsylvania

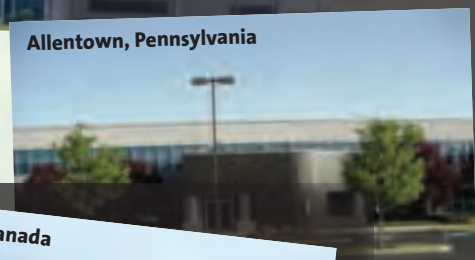

Oakville, Canada



Brookshire, Texas



4 • PUMP FEATURES

Dosing Products Overview

| PRODUCT FAMILY | | Mechanically actuated diaphragm | Hydraulically actuated diaphragm | Manual knob for stroke length control | Stroke speed control | Stroke frequency control | Digital control interface (key pad) | * Analog 4-20 mA control | * Pulse control | * Anti-cavitation/high viscosity mode | * Plus 3 system for auto-degassing option | * Flow monitoring option | * Available with duplex head | * Auto-degassing | * Autocal | * Flow Measurement | PAGES |
|---|--|---------------------------------|----------------------------------|---------------------------------------|----------------------|--------------------------|-------------------------------------|--------------------------|-----------------|---------------------------------------|---|--------------------------|------------------------------|------------------|-----------|--------------------|-------|
|  | DDA 0.0007 to 8 gph Up to 232 psi | ● | | | ● | | ● | ● | ● | ● | | ● | | ● | ● | ● | 8-9 |
|  | DDC 0.0015 to 4.0 gph Up to 150 psi | ● | | | ● | | ● | ● | ● | ● | | | | | | | 10-11 |
|  | DDE 0.0015 to 4.0 gph Up to 150 psi | ● | | | ● | | | | ● | | | | | | | | 12-13 |
|  | DME 0.02 to 248 gph Up to 145 psi | ● | | | ● | | ● | ● | ● | ● | | ● | | | | | 14-17 |
|  | DDI 0.10 up to 39.6 gph Up to 232 psi | ● | | | ● | | ● | ● | ● | ● | | ● | | | ● | | 18-19 |
|  | Plus 3 | ● | | | ● | | ● | ● | ● | ● | ● | ● | | | | | 20-21 |
|  | DMX 1.3 to 166.3 gph Up to 232 psi | ● | | ● | | ● | ● | ● | ● | | | | ● | | | | 22-23 |
|  | DMH 0.50 to 278 gph Up to 2900 psi | | ● | ● | | ● | ● | ● | ● | | | | ● | | | | 24-25 |

NOTE: Options vary depending on model number

* Optional

FLOW CAPACITY RANGES BY MODEL • 5

| MODEL | SIZE | GPH | PSI | Max SPM |
|---------|-----------|-------|-------|---------|
| DMH 280 | 1.3 - 200 | 0.50 | 2900 | 76 |
| DMH 281 | 2 - 100 | 0.60 | 1450 | 35 |
| DMH 251 | 2.2 - 25 | 0.69 | 363 | 17 |
| DMH 280 | 2.2 - 200 | 0.70 | 2900 | 115 |
| DMH 251 | 2.3 - 16 | 0.74 | 232 | 17 |
| DMH 251 | 2.4 - 10 | 0.77 | 145 | 17 |
| DMH 280 | 2.5 - 200 | 0.90 | 2900 | 144 |
| DMX 221 | 4 - 10 | 1.3 | 145 | 35 |
| DMH 281 | 4.2 - 100 | 1.30 | 1450 | 76 |
| DMH 251 | 4.5 - 25 | 1.43 | 363 | 35 |
| DMH 251 | 4.9 - 16 | 1.55 | 232 | 35 |
| DDE | 6-10 | 1.5 | 150 | 140 |
| DDC | 6-10 | 1.5 | 150 | 140 |
| DMH 281 | 6.4 - 100 | 2.00 | 1450 | 115 |
| DMX 221 | 7 - 10 | 2.1 | 145 | 35 |
| DMX 221 | 7.2 - 16 | 2.3 | 232 | 75 |
| DDA | 7.5-16 | 1.98 | 232 | 190 |
| DMH 288 | 7.5 - 200 | 2.40 | 2900 | 67 |
| DMH 281 | 8 - 100 | 2.50 | 1450 | 144 |
| DMX 221 | 8 - 10 | 2.6 | 145 | 75 |
| DDC | 9-7 | 2.4 | 100 | 200 |
| DMX 221 | 9 - 10 | 2.9 | 145 | 35 |
| DDA | 12-10 | 3.17 | 150 | 155 |
| DMH 252 | 10 - 16 | 3.17 | 232 | 35 |
| DMH 288 | 10 - 200 | 3.30 | 2900 | 88 |
| DMH 251 | 11 - 25 | 3.43 | 363 | 75 |
| DMH 252 | 11 - 10 | 3.45 | 145 | 35 |
| DMX 221 | 12 - 10 | 3.7 | 145 | 35 |
| DMH 251 | 12 - 16 | 3.70 | 232 | 75 |
| DMX 221 | 13.7 - 16 | 4.0 | 232 | 144 |
| DMH 288 | 13 - 200 | 4.10 | 2900 | 118 |
| DMH 251 | 13 - 10 | 4.22 | 145 | 75 |
| DMX 221 | 14 - 10 | 4.5 | 145 | 75 |
| DDE | 15-4 | 4.0 | 60 | 180 |
| DDC | 15-4 | 4.0 | 60 | 180 |
| DMH 288 | 15 - 200 | 4.90 | 2900 | 134 |
| DMX 221 | 16-10 | 5.0 | 145 | 144 |
| DDA | 17 - 7 | 4.5 | 101.5 | 205 |
| DMH 251 | 17 - 25 | 5.28 | 363 | 115 |
| DMX 221 | 17 - 4 | 5.3 | 58 | 35 |
| DMX 221 | 18 - 10 | 5.8 | 145 | 75 |
| DMH 287 | 18 - 200 | 5.80 | 2900 | 67 |
| DMH 251 | 18 - 16 | 5.81 | 232 | 115 |
| DMH 251 | 19 - 10 | 6.07 | 145 | 115 |
| DMH 283 | 19 - 100 | 6.10 | 1450 | 65 |
| DMH 285 | 20 - 100 | 6.30 | 1450 | 33 |
| DMH 253 | 21 - 10 | 6.60 | 145 | 35 |
| DMH 252 | 23 - 16 | 7.13 | 232 | 75 |
| DMH 287 | 23 - 200 | 7.40 | 2900 | 88 |
| DMH 252 | 24 - 10 | 7.66 | 145 | 75 |
| DMX 221 | 25 - 3 | 7.9 | 43.5 | 35 |
| DMX 221 | 26 - 10 | 8.2 | 145 | 75 |
| DMX 221 | 27 - 10 | 8.4 | 145 | 144 |
| DMH 283 | 27 - 100 | 8.40 | 1450 | 90 |
| DDA | 30-4 | 8 | 60 | 180 |
| DMH 287 | 31 - 200 | 9.80 | 2900 | 118 |
| DMH 283 | 33 - 100 | 10.60 | 1450 | 110 |

| MODEL | SIZE | GPH | PSI | Max SPM |
|---------|----------|--------|------|---------|
| DMX 221 | 35 - 10 | 11 | 145 | 144 |
| DMH 252 | 36 - 16 | 11.35 | 232 | 115 |
| DMH 287 | 36 - 200 | 11.40 | 2900 | 134 |
| DMH 252 | 37 - 10 | 11.62 | 145 | 115 |
| DMX 221 | 39 - 4 | 12 | 58 | 75 |
| DMH 283 | 40 - 100 | 12.70 | 1450 | 134 |
| DMH 285 | 40 - 100 | 12.70 | 1450 | 67 |
| DMH 253 | 43 - 10 | 13.70 | 145 | 75 |
| DDI 222 | 60 - 10 | 15.8 | 145 | 180 |
| DMH 254 | 50 - 10 | 15.80 | 145 | 32 |
| DME | 60 - 10 | 15.85 | 145 | 160 |
| DMX 221 | 50 - 10 | 16 | 116 | 144 |
| DMX 226 | 52 - 8 | 16.4 | 116 | 75.6 |
| DMH 285 | 52 - 100 | 16.60 | 1450 | 88 |
| DMX 221 | 60 - 3 | 19 | 43.5 | 75 |
| DMH 253 | 67 - 10 | 20.60 | 145 | 115 |
| DMX 226 | 67 - 10 | 21.1 | 145 | 68.4 |
| DMH 285 | 70 - 100 | 22.20 | 1450 | 118 |
| DMX 221 | 75 - 3.5 | 24 | 50.8 | 144 |
| DMH 285 | 80 - 100 | 25.30 | 1450 | 134 |
| DMX 226 | 82 - 5 | 25.9 | 72 | 75.6 |
| DMH 253 | 83 - 10 | 26.10 | 145 | 144 |
| DMH 286 | 85 - 50 | 26.90 | 725 | 67 |
| DMX 226 | 95 - 8 | 30 | 116 | 68.4 |
| DMH 254 | 97 - 16 | 30.60 | 232 | 65 |
| DMX 226 | 100 - 8 | 31.7 | 116 | 144 |
| DMH 254 | 102 - 10 | 32.20 | 145 | 65 |
| DMH 286 | 111 - 50 | 35.10 | 725 | 88 |
| DMX 221 | 115 - 3 | 36 | 36.3 | 144 |
| DDI 222 | 150 - 4 | 39.6 | 58 | 180 |
| DME | 150 - 4 | 39.6 | 58 | 160 |
| DMX 226 | 130 - 3 | 41.2 | 43.5 | 75.6 |
| DMX 226 | 132 - 10 | 41.7 | 116 | 144 |
| DMH 254 | 136 - 16 | 43.00 | 232 | 90 |
| DMH 254 | 143 - 10 | 45.40 | 145 | 90 |
| DMX 226 | 152 - 6 | 48 | 87 | 68.4 |
| DMX 226 | 160 - 5 | 50.7 | 72 | 144 |
| DMH 254 | 166 - 16 | 52.80 | 232 | 110 |
| DMH 286 | 170 - 50 | 53.90 | 725 | 134 |
| DMH 254 | 175 - 10 | 55.40 | 145 | 110 |
| DMH 255 | 194 - 10 | 61.50 | 145 | 65 |
| DMX 226 | 199 - 8 | 63.1 | 116 | 144 |
| DMH 254 | 202 - 16 | 63.90 | 232 | 134 |
| DMH 254 | 213 - 10 | 67.30 | 145 | 134 |
| DMH 257 | 220 - 10 | 69.70 | 145 | 33 |
| DMX 226 | 249 - 3 | 78.9 | 43.5 | 68.4 |
| DMX 226 | 255 - 3 | 80.8 | 43.5 | 144 |
| DMH 255 | 270 - 10 | 85.50 | 145 | 90 |
| DME | 375 - 10 | 99 | 145 | 160 |
| DMX 226 | 321 - 6 | 102 | 58 | 144 |
| DMH 255 | 332 - 10 | 105.00 | 145 | 110 |
| DMH 255 | 403 - 10 | 128.00 | 145 | 134 |
| DMH 257 | 440 - 10 | 139.40 | 145 | 65 |
| DMX 226 | 525 - 3 | 166.3 | 43.5 | 144 |
| DMH 257 | 575 - 10 | 182.20 | 145 | 90 |
| DMH 257 | 770 - 10 | 244.00 | 145 | 110 |
| DME | 940 - 4 | 248 | 58 | 160 |
| DMH 257 | 880 - 10 | 278.00 | 145 | 134 |

DMX 226 and DMH available in Duplex configuration for double capacity.

6 • CONTROL FEATURES BY MODEL

| | FCM | | DDA FC AR | | DDC AR A | | DDE P B | |
|--|-----|---|--------------|---|-------------|---|------------|---|
| CAPACITY CONTROL | | | | | | | | |
| Stroke speed control | ▲ | ▲ | ▲ | ▲ | ▲ | ▲ | ▲ | ▲ |
| CONTROL PANEL | | | | | | | | |
| Capacity setting in l/hr, ml/hr, or GPH | ▲ | ▲ | ▲ | ▲ | ▲ | | | |
| Display with soft touch buttons and background light | ▲ | ▲ | ▲ | ▲ | ▲ | | | |
| Circular menu | ▲ | ▲ | ▲ | ▲ | ▲ | | | |
| Multi-language options | ▲ | ▲ | ▲ | ▲ | ▲ | | | |
| Multi position control panel | ▲ | ▲ | ▲ | ▲ | ▲ | | | |
| Maximum capacity (priming) button | ▲ | ▲ | ▲ | ▲ | ▲ | ▲ | | |
| Green for operating indication screen | ▲ | ▲ | ▲ | ▲ | ▲ | | | |
| Red for fault indication screen | ▲ | ▲ | ▲ | ▲ | ▲ | | | |
| OPERATION MODES | | | | | | | | |
| Manual speed control | ▲ | ▲ | ▲ | ▲ | ▲ | ▲ | ▲ | ▲ |
| Pulse control in ml/pulse | ▲ | ▲ | ▲ | ▲ | ▲ | | | |
| Pulse control (1:n) | ▲ | ▲ | ▲ | ▲ | ▲ | ▲ | | |
| Analog control 0/4-20 mA input | ▲ | ▲ | ▲ | ▲ | | | | |
| Capacity adjustment knob (0.1 - 100%) | | | | | | | ▲ | ▲ |
| Start / Stop key | ▲ | ▲ | ▲ | ▲ | ▲ | ▲ | ▲ | ▲ |
| 100% key (de-aeration) | ▲ | ▲ | ▲ | ▲ | ▲ | ▲ | ▲ | ▲ |
| Operation mode switch (manual / pulse) | | | | | | | ▲ | |
| FUNCTIONS/OPTIONS | | | | | | | | |
| Dosing monitoring | ▲ | ▲ | | | | | | |
| Dual level control | ▲ | ▲ | ▲ | ▲ | ▲ | | | |
| Calibration function | ▲ | ▲ | ▲ | ▲ | ▲ | | | |
| Anti-cavitation (reduced suction speed) | ▲ | ▲ | ▲ | ▲ | ▲ | | | |
| Capacity limitation | ▲ | ▲ | ▲ | ▲ | ▲ | | | |
| Counter for strokes, operating hours, and power On/Off | ▲ | ▲ | ▲ | ▲ | ▲ | | | |
| Fieldbus communication Profibus (variant AP) | ▲ | ▲ | ▲ | ▲ | ▲ | | | |
| Overload protection | ▲ | ▲ | ▲ | ▲ | ▲ | | | |
| Error message in display | ▲ | ▲ | ▲ | ▲ | ▲ | | | |
| Leak detection | ▲ | ▲ | ▲ | | | | | |
| Dosing signal output | ▲ | ▲ | ▲ | | | | | |
| Analog 4-20 output | ▲ | ▲ | ▲ | | | | | |
| Relay output | ▲ | ▲ | ▲ | ▲ | | | | |

CONTROL FEATURES BY MODEL • 7

| |  |  |  |  |  |  |  |
|---|---|---|--|---|---|---|---|
| | DDI 222 | DME 60 to 940 AR | DME 60 to 940 B | DMX B | DMX AR | DMH B | DMH AR |
| CAPACITY CONTROL | | | | | | | |
| Stroke frequency control | | | | | ▲ | | ▲ |
| Stroke speed control | ▲ | ▲ | ▲ | | | | |
| Stroke length adjustments | | | | ▲ | ▲ | ▲ | ▲ |
| CONTROL PANEL | | | | | | | |
| Capacity setting in l/hr, ml/hr, or GPH | ▲ | ▲ | ▲ | ▲ | | | |
| Red light for stopped pump and error signals | ▲ | ▲ | ▲ | ▲ | ▲ | | ▲ |
| Green light when pump is running | ▲ | ▲ | ▲ | ▲ | ▲ | | ▲ |
| Yellow light to indicate pump remotely paused | ▲ | ▲ | ▲ | ▲ | ▲ | | ▲ |
| Control panel lock | ▲ | ▲ | ▲ | ▲ | ▲ | | ▲ |
| Start/Stop button | ▲ | ▲ | ▲ | ▲ | ▲ | | ▲ |
| Front-mounted interface | ▲ | ▲ | ▲ | ▲ | ▲ | | ▲ |
| Side-mounted interface | ▲ | ▲ | ▲ | ▲ | ▲ | | ▲ |
| Top-mounted interface | | ▲ | ▲ | ▲ | | | |
| Wall-mounted interface | | ▲ | ▲ | ▲ | ▲ | | ▲ |
| OPERATING MODES | | | | | | | |
| Manual control | ▲ | ▲ | ▲ | ▲ | ▲ | ▲ | ▲ |
| Pulse control | ▲ | ▲ | | | ▲ | | ▲ |
| Analog 0/4-20 mA control | ▲ | ▲ | | | ▲ | | ▲ |
| Pulse-based batch control | ▲ | ▲ | | | ▲ | | ▲ |
| Internal timer-based batch control | ▲ | ▲ | | | | | |
| FUNCTIONS/OPTIONS | | | | | | | |
| Alarm outputs (variant AR) | ▲ | ▲ | ▲ | | ▲ | | ▲ |
| Dosing controller output | | | | | ▲ | | ▲ |
| Flow monitor (variant AF) | ▲ | ▲ | | | | | |
| Leak detection (optional diaphragm breakage indication) | ▲ | ▲ | ▲ | | ▲ | ▲ | ▲ |
| Dual level control (requires level controller, available on select sizes) | ▲ | | | | ▲ | | ▲ |
| Auto degassing pump head (optional Plus3 system) | | | | | | | |
| Anti-cavitation/slow mode (reduced suction speed) | ▲ | ▲ | ▲ | ▲ | | | |
| Pulse memory (saves up to 65,000 pulses) | ▲ | ▲ | ▲ | | ▲ | | ▲ |
| Calibration function | ▲ | ▲ | ▲ | ▲ | | | |
| Resettable dosing quantity counter | ▲ | ▲ | ▲ | | | | |
| Hours of operation counter | ▲ | ▲ | ▲ | | ▲ | | ▲ |
| Remote On/Off | ▲ | ▲ | ▲ | | ▲ | | ▲ |
| 0/4-20 mA output | ▲ | | | | ▲ | | ▲ |
| Fieldbus communication (variant AP - Profibus) | ▲ | ▲ | ▲ | | | | |
| Available in Duplex versions (check size chart for availability) | | ▲ | ▲ | | ▲ | ▲ | ▲ |

8 • GRUNDFOS SMART DIGITAL DOSING™

DDA – SMART Digital Series Pumps (0.0007 to 8 gph)



The DDA SMART Digital dosing series represents the latest generation in Digital Dosing pumps from Grundfos. Its impressive intelligence and decision making capabilities go beyond any existing metering pump technology in the market.

The DDA can not only inject chemicals and verify injection; it can also measure valuable data such as flow or pressure. The pump can then diagnose the operation status based on the relationship between the diaphragm displacement and the pressure inside the head. The pump is so smart it can tell you if there are air bubbles inside the head. This technology goes even further. Thanks to its impressive logic capabilities, the DDA can make decisions to display and/or correct failures such as overpressure, valve leaks or air bubbles.

Smooth and Continuous Dosing

Ensures an optimum mixing ratio at the injection point without the need for additional accessories, such as static mixers. It also provides significant reduction of pressure peaks, preventing mechanical stress on wearing parts such as diaphragm, tubing, and connections, resulting in less maintenance required.

Full Stroke Length at All Times

The pump always operates at full stroke length, irrespective of the capacity set; this ensures maximum volume displacement per stroke, optimum accuracy, easy priming and improved suction.

Up to 3000:1 Turndown Ratio

The Digital Dosing range is designed to give you superior flexibility and accuracy even when dosing very small volumes.

Maximum Capacity Setting

With the DDA series you decide what the maximum capacity should be. You can select any value within the performance range of each model and the pump will redefine the injection speed and adjust the operation scale within that range. So you only need a few models to cover multiple applications.

Anti-Cavitation / SlowMode

The variable speed of DDA pumps facilitates a unique anti-cavitation function for high viscosity liquids. This function provides slower suction speed (50 or 25% of the maximum speed), ensuring optimal priming and pumping of even the most difficult liquids.

Flow Monitoring

The DDA FCM pump can precisely measure and display the actual dosing flow. Via the analog 0/4-20 mA output, the actual flow signal can easily be integrated in any process control system, without needing additional measurement equipment.

Pressure Monitoring

The integrated pressure sensor measures the actual pressure of the system, which is shown in the display. In case of an overpressure situation, the pump will stop injecting, generate an alarm on the display, and trigger a relay. The pressure can also be monitored via the 4-20mA signal output.

AutoFlowAdapt

The DDA FCM pump can recognize pressure fluctuations on the discharge line and adapt the speed to compensate the injection, maintaining a constant feeding set point.

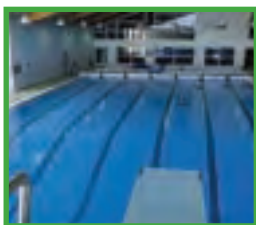

Dimensions [inches (mm)]

| | DDA 7.5 | DDA 12 | DDA 17 | DDA 30 |
|---|-------------|--------------|--------------|--------|
| A | 11 (280) | 11 (280) | 11.61 (295) | |
| B | 7.72 (196) | 7.89 (200.5) | 8.05 (204.5) | |
| C | 1.83 (46.5) | 1.55 (39.5) | 1.39 (35.5) | |
| D | 0.94 (24) | 0.94 (24) | 1.51 (38.5) | |

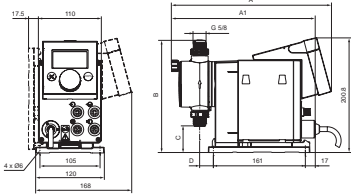

Product Range and Performance Data

| Pump type | Capacity | DDA 7.5-16 | DDA 12-10 | DDA 17-7 | DDA 30-4 |
|---------------------------|-----------|------------|-----------|-----------|----------|
| Capacity at max. pressure | g/h (l/h) | 1.98 (7.5) | 3.17 (12) | 4.5 (17) | 8 (30) |
| Max. pressure | psi (bar) | 232 (16) | 150 (10) | 101.5 (7) | 60 (4) |
| Setting range | | 3000:1 | 1000:1 | 1000:1 | 1000:1 |

| | | | | | |
|--------------------------|--------|-----------------------|-----------------------|-----------------------|-----------------------|
| Stroke frequency | spm | 190 | 155 | 205 | 180 |
| Suction lift: primed/dry | ft (m) | 19.6 (6)/6.5 (2) | 19.6 (6)/9.8 (3) | 19.6 (6)/9.8 (3) | 19.6 (6)/6.5 (2) |
| Viscosity (slow mode)* | cps | 2500/50 | 2500/300 | 2000/300 | 1500/150 |
| Power supply | V, Hz | 100-240 V 50/60 Hz | 100-240 V 50/60 Hz | 100-240 V 50/60 Hz | 100-240 V 50/60 Hz |
| Accuracy | % | +/-1 | + / -1 | + / -1 | +/-1 |

*With Spring-Loaded valves

Performance Range

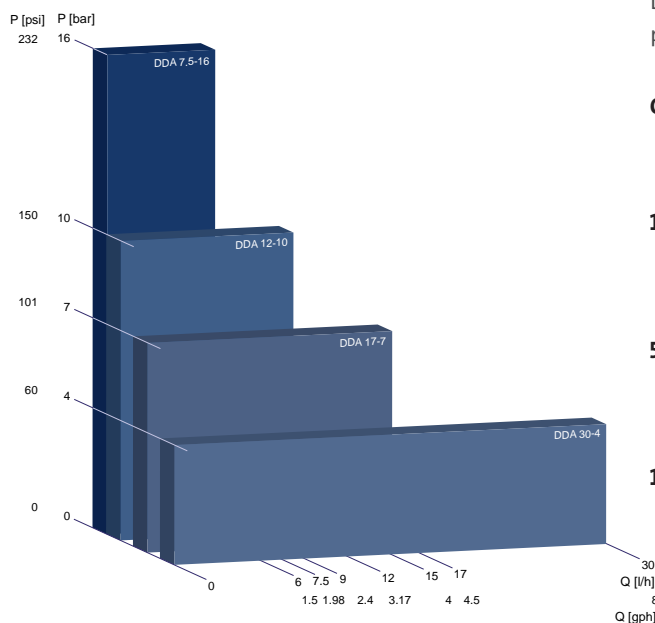

Functional Description

DDA's electronically controlled variable-speed (stepper) motor provides optimum control of the stroke speed.

Capacity setting

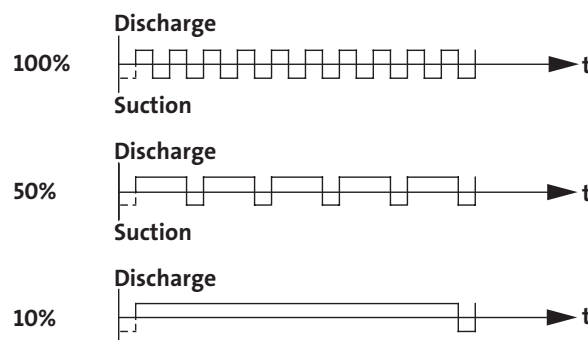

Relation between stroke-frequency adjustment and capacity

10 • GRUNDFOS SMART DIGITAL DOSING™

DDC – SMART Digital Series Pumps (0.0015 to 4.00 gph)



The DDC SMART Digital dosing series represents the latest generation in Digital Dosing pumps from Grundfos. Available in three sizes and two control options, the DDC range brings continuity for the well known DME and DDI digital dosing lines.

With its 1000:1 turn down ratio, removable mounting bracket and flexible control panel installation, the DDC product range brings simplicity and flexibility to adapt your pump and cover a great variety of metering applications.

Smooth and Continuous Dosing

The DDC stepper motor technology ensures an optimum mixing ratio at the injection point without the need for additional accessories such as static mixers. It also provides a significant reduction of pressure peaks, preventing mechanical stress on wearing parts such as diaphragm, tubing, and connections, resulting in less maintenance required.

Full Stroke Length at All Times

The pump always operates at full stroke length, irrespective of the capacity set; this ensures maximum volume displacement per stroke, optimum accuracy, easy priming and improved suction.

1000:1 Turndown Ratio

The Digital Dosing range is designed to give you superior flexibility and accuracy even when dosing very small volumes.

Maximum Capacity Setting

With the DDC series you decide what the maximum capacity should be. You can select any value within the performance range of each model and the pump will redefine the injection speed and adjust the operation scale within that range. So you only need a few models to cover multiple applications.

Anti-Cavitation / SlowMode

The variable speed of DDC pumps facilitates a unique anti-cavitation function for high viscosity liquids. This function gives you slower suction speed (50 or 25% of the maximum speed), ensuring optimal priming and pumping of even the most difficult liquids.

Calibration

With Digital Dosing, calibration is easier and faster than ever. Simply place a graduated glass under the pump and activate the calibration program. The pump will perform 100 strokes and indicate how much it thinks it has pumped. Adjust the figure by entering the correct numbers if necessary. After this, the dosage can be adjusted without recalibrating the pump.

Different Control Options and Materials

Available in two different control options: A /AR. The DDC series has the right pump for each application.

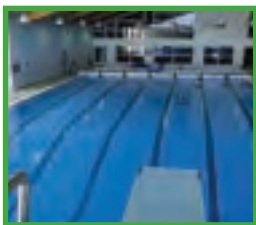

Dimensions [inches (mm)]

| | DDC 6 | DDC 9 | DDC 15 |
|---|-------------|--------------|--------|
| A | 11 (280) | 11 (280) | |
| B | 7.72 (196) | 7.89 (200.5) | |
| C | 1.83 (46.5) | 1.55 (39.5) | |
| D | 0.94 (24) | 0.94 (24) | |

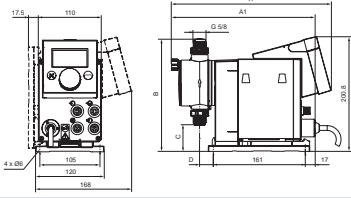

Product Range and Performance Data

| Pump type | Capacity | DDC 6-10 | DDC 9-7 | DDC 15-4 |
|---------------------------|-----------|----------|---------|----------|
| Capacity at max. pressure | g/h (l/h) | 1.5 (6) | 2.4 (9) | 4.0 (15) |
| Max. pressure | psi (bar) | 150 (10) | 100 (7) | 60 (4) |
| Setting range | | 1000:1 | 1000:1 | 1000:1 |

| | | | | |
|--------------------------|--------|-----------------------|-----------------------|-----------------------|
| Stroke frequency | spm | 140 | 200 | 180 |
| Suction lift: primed/dry | ft (m) | 19.6 (6)/6.5 (2) | 19.6 (6)/6.5 (2) | 19.6 (6)/9.8 (3) |
| Viscosity* | cps | 2500/50 | 2000/50 | 2000/300 |
| Power supply | V, Hz | 100-240 V 50/60 Hz | 100-240 V 50/60 Hz | 100-240 V 50/60 Hz |
| Accuracy | % | +/-1 | + / -1 | + / -1 |

*With Spring-Loaded valves

Performance Range

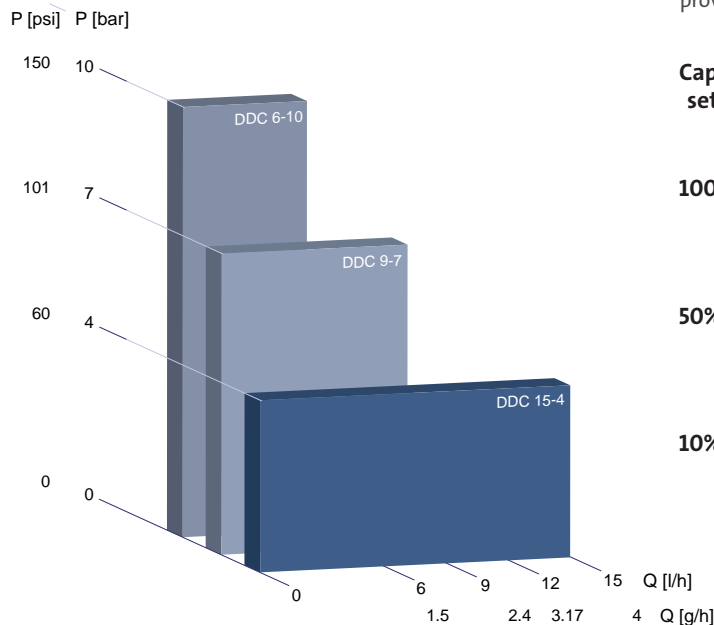

Functional Description

DDA's electronically controlled variable-speed (stepper) motor provides optimum control of the stroke speed.

Capacity setting

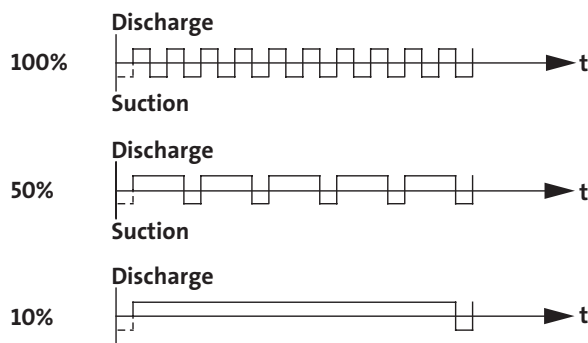

Relation between stroke-frequency adjustment and capacity

12 • GRUNDFOS SMART DIGITAL DOSING™

DDE – SMART Digital Series Pumps (0.0015 to 4.00 gph)



The DDE SMART Digital dosing series represents the latest generation on the Digital Dosing pumps from Grundfos. Available in two sizes and two control options, the DDE range represents an economic and simple alternative for basic dosing applications.

Although it appears to be a solenoid pump, the DDE is actually STEPPER MOTOR DRIVEN. Whichever model you choose, you get a sturdy, cost-efficient pump based on a well-proven stepper motor design.

With its 1000:1 turn down ratio, removable mounting bracket and easy to use control knob, the DDE product range brings simplicity and a budget-friendly solution for chemical injection.

Smooth and Continuous Dosing

The DDE stepper motor technology ensures optimum mixing ratio at the injection point without the need for additional accessories, such as static mixers. It also provides a significant reduction of pressure peaks, preventing mechanical stress on wearing parts such as diaphragm, tubing, and connections, resulting in less maintenance required.

Full Stroke Length at All Times

The pump always operates at full stroke length, irrespective of the capacity set; this ensures maximum volume displacement per stroke, optimum accuracy, easy priming and improved suction.

1000:1 Turndown Ratio

The Digital Dosing range is designed to give you superior flexibility even when dosing very small volumes.

Easy Priming (P Model only)

The convenient and efficient priming button makes tedious priming processes a thing of the past. Simply push the button and set the number of seconds you want the pump to prime for, and the pump will do it for you.

Silent Operation

Regardless of model, the DDE pump is among the most quiet of its type available on the market today. It keeps its noise emission down to just 60 dB(A).

Different Control Options and Materials

Available in two different control options: B / P (Basic / Pulse). The DDE series is an economic alternative for many applications—stainless steel, PVC, PVDF, and polypropylene for an environmentally-friendly and cost-efficient alternative.



Dimensions [inches (mm)]

| | DDE 6 | DDE 15 |
|---|-------------|--------------|
| A | 11 (280) | 11 (280) |
| B | 7.72 (196) | 7.89 (200.5) |
| C | 1.83 (46.5) | 1.55 (39.5) |
| D | 0.94 (24) | 0.94 (24) |

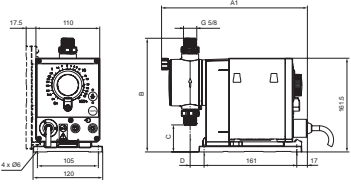

Product Range and Performance Data

| Pump type | Capacity | DDE 6-10 | DDE 15-4 |
|---------------------------|-----------|----------|----------|
| Capacity at max. pressure | g/h (l/h) | 1.5 (6) | 4.0 (15) |
| Max. pressure | psi (bar) | 150 (10) | 60 (4) |
| Setting range | | 1000:1 | 1000:1 |

| | | | |
|--------------------------|--------|-----------------------|-----------------------|
| Stroke frequency | spm | 140 | 180 |
| Suction lift: primed/dry | ft (m) | 19.6 (6)/6.5 (2) | 19.6 (6)/9.8 (3) |
| Viscosity* | cps | 600/50 | 500/50 |
| Power supply | V, Hz | 100-240 V 50/60 Hz | 100-240 V 50/60 Hz |
| Accuracy | % | +/-5 | + / -5 |

*With Spring-Loaded valves

Performance Range

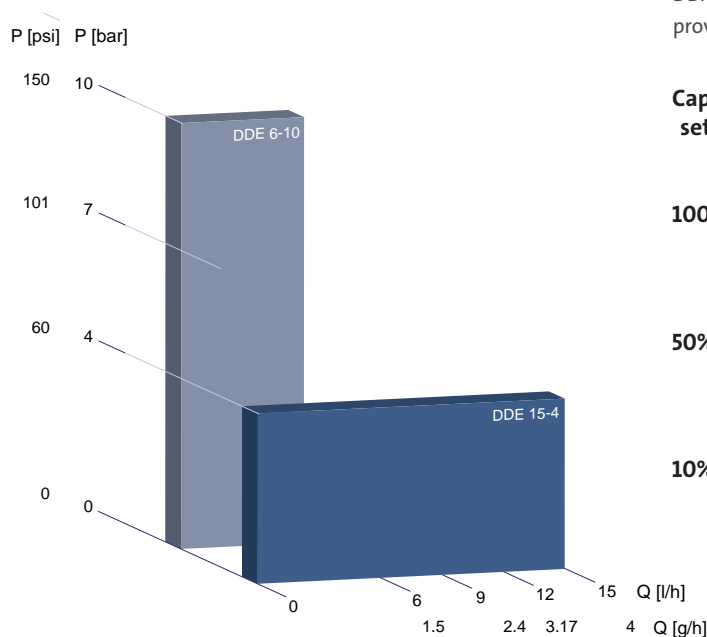

Functional Description

DDA's electronically controlled variable-speed (stepper) motor provides optimum control of the stroke speed.

Capacity setting

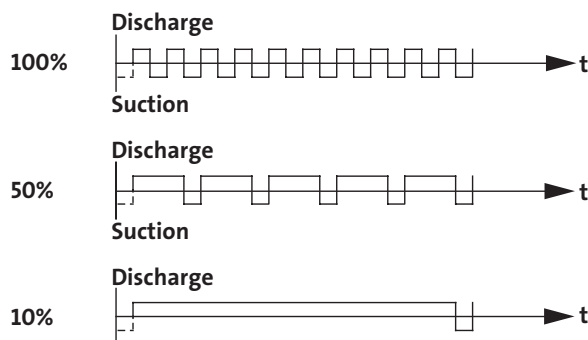

Relation between stroke-frequency adjustment and capacity

14 • GRUNDFOS DIGITAL DOSING™

DME 60/150 – Larger Pumps from 0.02 to 39.7 gph (150 l/h)



Grundfos has applied innovative technology to expand the Digital Dosing pump range, allowing it to handle liquids in much larger quantities. Perfect for large water and wastewater treatment plants, textile industries, pulp and paper industries, and many other demanding applications, the new, large DME pumps bring the benefits of Digital Dosing to a new circle of users worldwide.

Familiar Digital Dosing Benefits

The large DME pumps have all the benefits of the highly acclaimed smaller Digital Dosing range, making exact dosing easier than ever.

Easy-To-Use Digital User Interface

The simple display allows everyone to be their own dosing specialist. With just a few buttons, you can navigate the straightforward menus to use the impressive range of standard control features – including pulse, analog, timer, batch, and anti-cavitation control – as well as simple calibration and much more.

Turndown Ratio 800:1

Digital Dosing pumps can be adjusted to 1/800 of their maximum capacity. Two new sizes provide even more flexibility, from 0.02 to 39.6 GPH (75 to 150 ml/h).

Full Stroke Length at All Times

Grundfos is the only pump manufacturer to use a full stroke length every time. The speed of each stroke is carefully timed, ensuring even concentration in the system and optimal priming throughout the entire operating range.

Smooth, Continuous Dosing

A brushless DC motor eliminates the need for a servo motor/frequency converter. The result is smooth, continuous dosing, which greatly improves the performance of sensors and measuring devices that read the impact of your chemical feed program.

Anti-Cavitation

For handling viscous polymers or other difficult liquids, slow down the speed of the suction stroke to 75%, 50%, or 25% of the maximum speed.

Fieldbus Communication Available

Available with Profibus interface.

Overload Protection

Built-in overload protection monitors pump counter pressure and protects against exceptionally high pressure loads.

Switch-Mode Power Supply

The switch-mode power supply ensures that Grundfos Digital Dosing pumps can be used worldwide within the 100–240V, 50/60Hz range.

Several Material Variants

The DME pump heads are available in stainless steel, PVDF, and environmentally friendly, cost-efficient polypropylene.

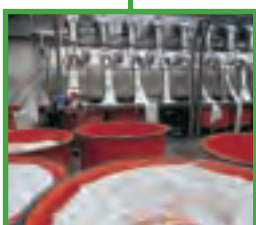
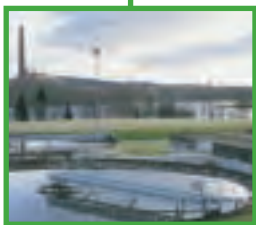

Dimensions [inches (mm)]

| | DME 60-10 | DME 150-4 | |
|---|-------------|-------------|--|
| A | 6.93 (176) | | |
| B | 7.8 (198) | | |
| C | 13.03 (331) | 13.58 (345) | |
| D | 11.18 (284) | | |
| E | 7.09 (180) | | |
| F | 17.48 (444) | | |
| G | 1.61 (41) | 1.10 (28) | |
| H | 2.91 (74) | | |
| I | 7.36 (187) | | |

Product Range and Performance Data

| Pump type | | DME 60-10 | DME 150-4 |
|--------------------------------|-----------|---------------------------|----------------|
| Max. capacity at max. pressure | GPH (l/h) | 15.85 (60) | 39.6 (150) |
| Min. capacity | GPH (l/h) | 0.0198 (0.075) | 0.0497 (0.188) |
| Max. pressure | psi (bar) | 145 (10) | 58 (4) |
| Setting range | | 800:1 | |
| Stroke frequency | spm | 160 | |
| Power supply | V, Hz | 1×100-240V, 50-60 Hz | |
| Accuracy | % | ±1% repeatability | |
| Pump head material | | PP, PVDF, stainless steel | |
| Suction lift: primed/dry | ft [m] | [6/1.5] | |
| Viscosity* | cps | 3000 at 50% capacity | |

*With Spring-Loaded valves

Performance Range

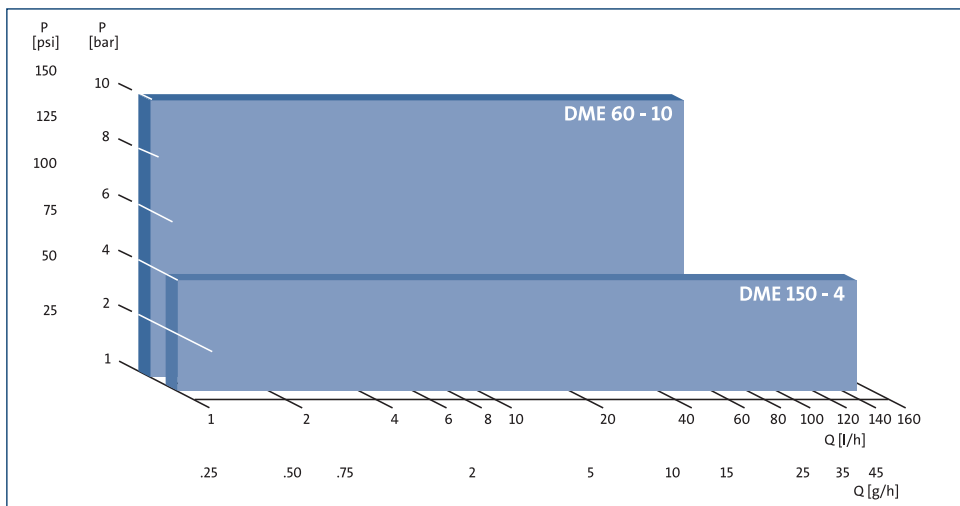

DME 375/940 – Exact Dosing from 0.13 to 248 gph (940 l/h)



Grundfos has applied the innovative technology of Digital Dosing to expand the performance range of these precision metering pumps. The large DME is perfect for water and wastewater treatment plants, textile and pulp & paper industries, and many other demanding applications.

Familiar Digital Dosing Benefits

The DME 375 and 940 have all the benefits of the highly acclaimed smaller models but offer precision performance at much higher capacities. Available materials include polypropylene, PVDF, and 316 stainless steel.

Easy to Use Interface

The intuitive menu structure is extremely easy to use. Use the keypad to set the desired flow in gph (or l/h). With just the touch of a button, navigate the menu to use the impressive range of standard automatic control features, including pulse, analog, batch or internal timer control. Confirm that “what you set is what you get” by running a quick and simple calibration.

Smooth, Continuous Feed

The 800:1 turndown ratio means the large DME will continuously deliver chemicals down to 1/800 of full speed. Precise speed control of the brushless DC motor eliminates the need for a servo-motor/frequency converter or additional variable speed drives.

Accurate Through Its Entire Adjustable Range

DME pumps always perform at 100% stroke length. Motor speed is carefully timed to deliver the desired feed rate, even in pulse and analog control modes without pausing to rest in between strokes.

Additional Features

- Anti-cavitation: slows down the suction stroke speed 75%, 50%, or 25% to facilitate handling viscous fluids
- Overload protection: will stop the pump if the maximum pressure load is exceeded
- Fieldbus communication: available with Profi-bus interface
- Switch-mode power supply: 100-240 VAC, 50/60 Hz to facilitate use around the globe.

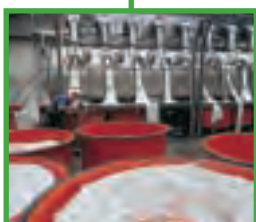

Dimensions [inches (mm)]

| | DME 375-10 | DME 940-4 |
|---|-------------|-------------|
| A | 9.37 (238) | 9.37 (238) |
| B | 8.58 (218) | 8.58 (218) |
| C | 18.54 (471) | 19.53 (496) |
| D | 14.33(364) | 14.33(364) |
| E | 9.06 (230) | 9.06 (230) |
| F | 21.26 (540) | 21.22 (539) |
| G | 1.22 (31) | .24 (6) |
| H | 3.74 (95) | 3.74 (95) |
| I | 9.69 (246) | 9.69 (246) |

Product Range and Performance Data

| Pump type | | DME 375-10 | DME 940-4 |
|--------------------------------|----------------------|----------------------|-------------|
| Max. capacity at max. pressure | gph (l/h) | 99.1 (375) | 248.3 (940) |
| Min. capacity | gph (l/h) | 0.124 (0.47) | 0.31 (1.18) |
| Max. pressure | psi (bar) | 145 (10) | 58 (4) |
| Setting range | | 800:1 | |
| Stroke frequency | [min ⁻¹] | 160 | |
| Power supply | [V], [Hz] | 1×100-240V, 50-60 Hz | |
| Accuracy | % | ±1% repeatability | |
| Pump head material | | PP, PVDF, 316 SS | |
| Suction lift: primed/dry | ft [m] | 19/4.9 [6/1.5] | |
| Viscosity* | [cps] | 3000 at 50% capacity | |

*With Spring-loaded valves

Performance Range

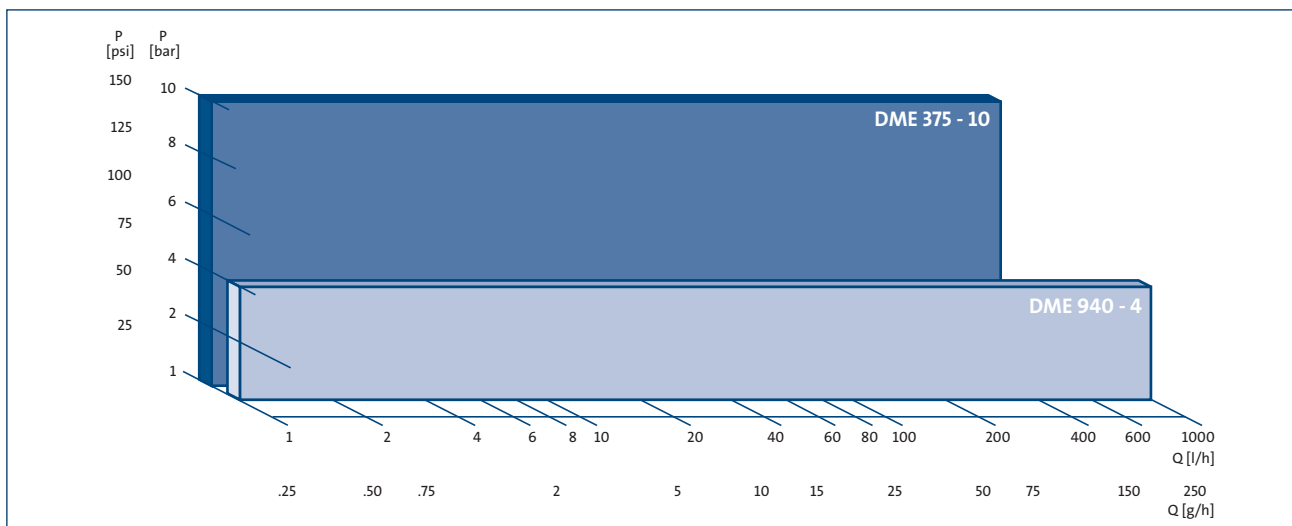

DDI 222 – Perfect Precision from 0.019 to 39.6 gph (0.6 to 150 l/h)



The Difference is Digital

The Grundfos DDI range was created because accurate dosing demands precision. These compact units combine perfect precision with a user interface that lets you set the dosing feed rate you want directly on the pump – without spending time on complicated calculations beforehand. Available materials include PVC, PVDF, polypropylene, and 316 stainless steel.

The DDI AR: Taking Diaphragm Dosing Pumps to the Next Level

The DDI AR series is the backbone of the overall DDI range. Its innovative drive technology combines a powerful EC motor with integrated contact signal control to bring you smoother, nearly continuous, and more accurate dosing for the optimal mixing of liquids. The EC motor technology also lowers energy costs while still providing maximum efficiency.

Two Slow Mode steps and special valve combinations can be used for handling of more viscous liquids. The user interface gives you a full range of options for customizing the dosing process. Contact or analogue signal controls and batch or timer dosing are just some possibilities for specific applications.

The DDI AF: Built-In Flow Monitor

The DDI AF models have all of the overall DDI benefits: it doses, measures, and detects gases from the pump head, cavitation, and pressure changes that result from line breaks or a blocked discharge line. It eliminates the need for additional equipment by combining precision dosing and continuous flow measurement in a single unit.

With a radical reduction in variants and spare parts, you only need one motor, one gearing, and two dosing head sizes to fit the complete pump series.

Easy Input and User-Friendly Display

The DDI features easy input and display of the dosing rate in l/h or gal/h, with perfect calibration for optimum operating convenience and unparalleled levels of precision. There's also a hotkey for easy query of the dosed quantity, allowing optimal control of the consumption of chemicals. Control excess pressure of the pump by digitally inputting the maximum backpressure allowed before the pump stops.

Turndown Ratio of 800:1

The DDI range is designed to give you superior flexibility and accuracy with as few product variants as possible. That is why you can slow down the feed rate to 1/800 the pump's maximum capacity without any loss of accuracy.

The DDI series can dose additive in quantities down to 0.019 GPH (0.0029 l/h) with perfect precision. Evidence of this precision can be provided at any time while the pump is running — it runs with nearly continuous flow, with no pauses between strokes.

Double Diaphragm System with Diaphragm Control for Pump Protection

Double diaphragm technology comes as a standard option on DDI model 222. This option affords high process reliability. If there is a working diaphragm defect, the pump continues to dose with the robust protective diaphragm.

The diaphragm control is optional. For applications where the process must not be interrupted in the event of a diaphragm leakage, a differential pressure sensor is optionally available. In the event of a working diaphragm leakage, the sensor immediately sends out a signal, while the pump continues to dose with the protective diaphragm. (See figure at right.)

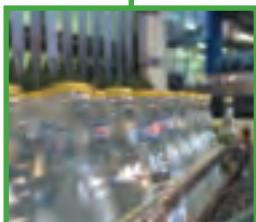
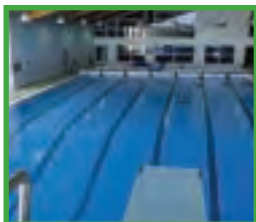

DDI 222 Dimensional Data

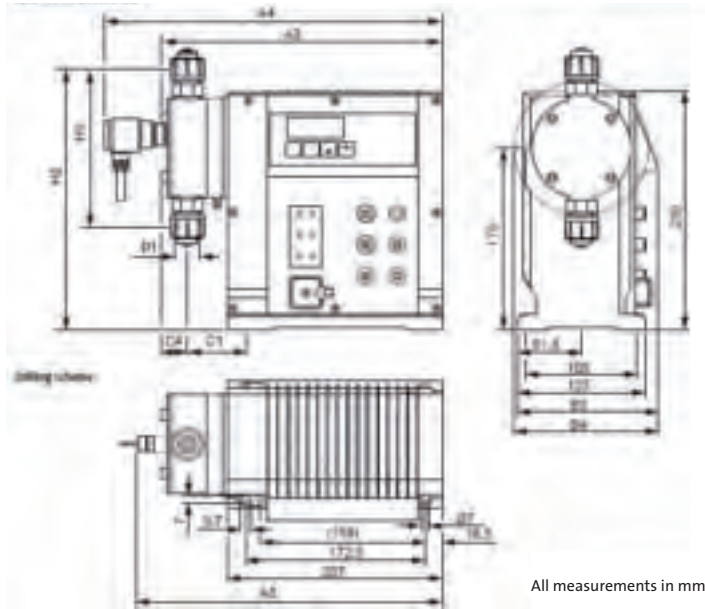

| DDI Models | A3 | A4 | B3 | B4 | C1 | C4 | D1 | H2 | H3 | Version for high-viscosity liquids (HV) | | | | |
|------------|-----|-----|-----|-----|----|----|------|-----|-----|---|----|------|-----|-----|
| | | | | | | | | | | C1 | C4 | D1 | H2 | H3 |
| 222-60D | 272 | 326 | 137 | - | 58 | 26 | G½" | 252 | 153 | 90 | 39 | G1¼" | 246 | 143 |
| 222-150D | 315 | 372 | 137 | 139 | 90 | 39 | G1¼" | 265 | 179 | 90 | 39 | G1¼" | 265 | 179 |

DDI 222 Technical Data

| | | | | |
|--|---|---|--|---|
| Input of the dosing capacity | Digital – by regulation of the dosing stroke speed Adjustment range: from 0.125% to 100% of the maximum dosing capacity | | | |
| Accuracy | Dosing flow < ± 1.5%, linearity < ± 1.5% | | | |
| Noise level | 65 ± 5 dB (A), tested according to DIN 45635-01-KL3 | | | |
| Max. suction height: primed/dry | 19.7 primed (DDI 60) / 9.8 primed (DDI 150) / 3.3 ft Dry | | | |
| Max. viscosity (HV version) at operating temperature | DDI model 222-60D 222-150D | Normal operation 200 mPa s 500 mPa s | Slow Mode 1 1000 mPa s 800 mPa s | Slow Mode 2 2600 mPa s 2000 mPa s |
| Max. admission pressure | 2 bar on the suction side | | | |
| Min. backpressure | 1 bar (pressure difference with the suction side) | | | |
| Max. temperature | <ul style="list-style-type: none"> max. ambient and operating temperature +40°C storage temperature -10°C up to +50°C | | | |
| Power supply | AC 110 - 240 V ±10%, 50/60 Hz, power consumption 50 W (including all sensors) | | | |
| Protection | IP 65 | | | |
| Weight | DDI model 222-60D DDI model 222-150D | PVC,PP,PVDF: 5 kg / stainless steel: 7 kg PVC,PP,PVDF: 7.5 kg / stainless steel: 12 kg | | |

DDI 222 Flow Capacities

| NORMAL OPERATION | | | | SLOW MODE STEP 1 | | | | SLOW MODE STEP 2 | | | | V _{stroke} [ml] (p=3 bar) | DDI MODEL |
|------------------|------------------------|-----------|------------------------|------------------|------------------------|-----------|------------------------|------------------|------------------------|-----------|------------------------|--|-----------------|
| Q [l/h] | P _{max} [bar] | Q [USg/h] | P _{max} [psi] | Q [l/h] | P _{max} [bar] | Q [USg/h] | P _{max} [psi] | Q [l/h] | P _{max} [bar] | Q [USg/h] | P _{max} [psi] | | |
| 60 | 10 | 15.87 | 145 | 40 | 10 | 10.58 | 145 | 24.7 | 10 | 6.53 | 145 | 6.63 | 222-60D |
| 150 | 4 | 39.68 | 58 | 100 | 4 | 26.46 | 58 | 62 | 4 | 16.40 | 58 | 13.9 | 222-150D |

20 • GRUNDFOS DIGITAL DOSING™

Plus 3 System for Automatic Deaeration and Calibration



Degassing and Calibration Unit for Your DMI and DDI Pumps

The Plus³ system is a deaeration and calibration unit that enables your dosing pump to handle volatile liquids. Briefly put, it removes gas from the liquid being dosed and makes continuous calibration possible while the pump is in operation.

The Plus³ system allows for reliable dosing of volatile media, accurate dosing of very small quantities, and precise dosing of concentrated, or neat, liquids. Designed as an option for use with the DMI and DDI models, the Plus³ system lets you get the most out of your dosing pump.

Reliable Dosing of Sodium Hypochlorite

The Plus³ system is based on a patented double-diaphragm design which removes air in the dosing media, thereby insuring completely accurate dosing. Fluids like sodium hypochlorite that can cause many pumps to gas lock and lose prime are handled with ease using the Plus³ system.

The usual problems associated with such high-precision dosing are avoided by having the Plus³ unit lift a large quantity of liquid into the priming chamber. Here, it is deaerated so that all gas bubbles are removed before the exact dose required is added to your process. The unwanted air is vented into the atmosphere, while the surplus liquid is returned to the container for later use.

Continuous Calibration

The Plus³ system includes a compact integrated calibration system. This allows for accurate control and adjustment of the dosing rates at any time. You won't need to interrupt the process, no additional calibration devices are necessary, and no chemicals are wasted. The net result is simple: The calibration system saves you time and money.

Change Tanks During Operation

Because of the small reservoir built into the pump head, the Plus³ system allows you to change the feed tank while the pump is running – a definite plus for disinfection processes.



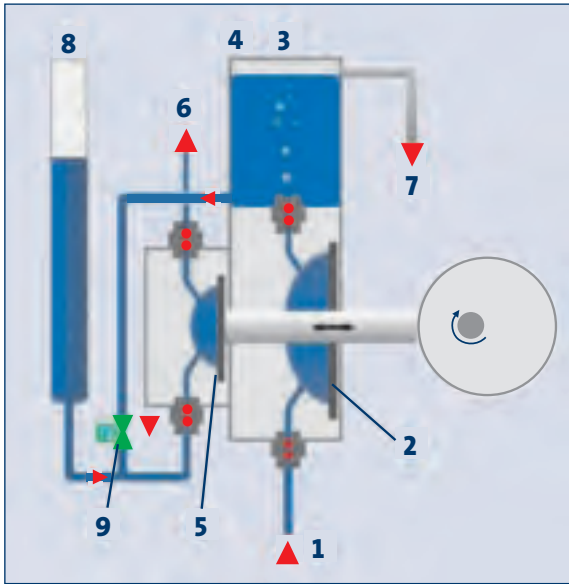

The Plus³ system employs a patented double diaphragm design to optimize dosing accuracy.

How it works:

- The first diaphragm (2) draws in a large amount of dosing media from the dosing tank (1) and transfers it into the priming chamber (3) for deaeration. This eliminates the problems associated with drawing-in of very small quantities.
- (4) Any gas bubbles in the liquid are vented into the atmosphere.
- The second diaphragm (5) doses the exact amount of liquid required into the dosing line (6).
- Excess liquid is returned to the tank through the deaeration bypass (7).
- The integrated calibration tube (8) and valve (9) allow for precise calibration of the dosing flow while the pump is running.

Performance Range

| Model | Size | Capacity |
|-------|----------|---------------------------------------|
| DDI | 0,4 - 10 | 0.10 gph/145 psi |
| | 2,2 - 16 | 0.50 gph/232 psi |
| | 2,5 - 10 | 0.58 gph/145 psi |
| | 5,5 - 10 | 1.29 gph/145 psi |
| DMI | 0,3 - 10 | 0.08 gph/43.5 psi 0.05 gph/145 psi |
| | 0,8 - 16 | 0.42 gph/145 psi 0.13 gph/232 psi |
| | 1,0 - 10 | 0.42 gph/43.5 psi 0.21 gph/145 psi |
| | 1,1 - 16 | 0.71 gph/145 psi 0.44 gph/232 psi |
| | 1,6 - 10 | 0.71 gph/43.5 psi 0.55 gph/145 psi |
| | 3,0 - 10 | 0.98 gph/43.5 psi 0.87 gph/102 psi |
| | 3,6 - 16 | 1.43 gph/145 psi 1.11 gph/232 psi |
| | 4,0 - 8 | 1.43 gph/43.5 psi 1.27 gph/87 psi |
| | 6,0 - 8 | 1.85 gph/43.5 psi 1.65 gph/87 psi |

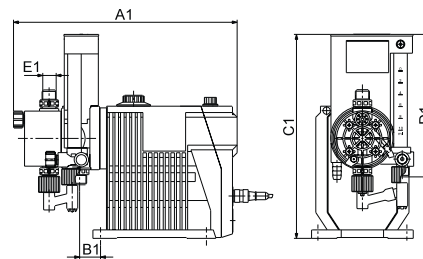

DMI with Plus³ system

| | |
|-------------|--------------|
| Pump | DMI 0.3 - 10 |
| A1 | 10.28 |
| B1 | 0.99 |
| C1 | 9.88 |
| D1 | 7.78 |
| E1 | G 3/8 |

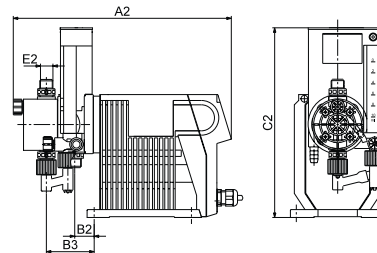

DDI 209 AR with Plus³ system

| | |
|--------------|--------------|
| Pump | DDI 0,4 - 10 |
| Model | 209 AR |
| A2 | 10.87 (276) |
| B2 | 0.98 (25) |
| B3 | 2.4 (61) |
| C2 | 9.45 (240) |
| E2 | G 3/8 |

22 • GRUNDFOS MECHANICAL AND HYDRAULIC DOSING

DMX – Reliable Dosing from 0.13 to 2 x 166 gph (630 l/h)



DMX 221 and 226 – Versatility Through Choice

The Grundfos DMX is a series of high-quality mechanically actuated diaphragm pumps suitable for many uses, such as drinking water treatment, wastewater treatment, and the pulp/paper and textile industries. This series is designed to be highly versatile, which is reflected in the wide flow range covered and the choice of dosing head sizes, materials, and accessories available. If in doubt, ask us – we will help you configure the DMX that is best for you.

Manual or Remote Reliable Control

DMX B models feature a manual stroke length adjustments for a 10:1 turndown ratio. For additional control the DMX AR features a micro-processor controller with:

- Precise and automatic proportional feed
- Manual stroke frequency control
- 0(4)-20 mA or pulse control
- Menu driven display with user-friendly interface
- Low-level and empty output
- Remote on/off control

Choose the Materials – and Size – That Suit You

Both the DMX 221 and 226 liquid ends are available in PVC, PVDF, polypropylene, and stainless steel. For additional output and flexibility, the DMX 226 is available in a duplex version.

Accessories Insure Perfect System Integration

A wide range of accessories specially designed for the Grundfos DMX series help optimize performance. This makes commissioning fast and easy. Other accessories are also available to make sure that your Grundfos DMX fits your system exactly, such as:

- Back pressure valves for dosing systems with no or varying back pressure
- Servomotor for remote stroke length control via 4-20 mA input
- DMX AR dosing controller with output to indicate a loss
- DMX AR with leak detection
- DMX with integrated pressure relief valve in the pump head



Technical Specifications

| DMX 221 Pump | Max capacity | | SPM (at 60 Hz) | Max Viscosity* cps | Max suction lift* | | Motor voltage | Accuracy flow | Linearity |
|--------------|--------------|------------|-------------------|-----------------------|-------------------|----------|-------------------|---------------|-----------|
| | GPH (l/hr) | psi (bar) | | | Primed (ft) | Dry (ft) | | | |
| 4-10 | 1.3 (5) | 145 (10.0) | 35 | 400 | 13.1 | 13.1 | 1∅ 115V, 50/60 Hz | +/- 1.5% | +/- 4% |
| 7-10 | 2.1 (8) | 145 (10.0) | 35 | 400 | 13.1 | 13.1 | | | |
| 7,2-16 | 2.3 (8.6) | 232 (16.0) | 75 | 400 | 13.1 | 13.1 | | | |
| 8-10 | 2.6 (10) | 145 (10.0) | 75 | 400 | 13.1 | 13.1 | | | |
| 9-10 | 2.9 (11) | 145 (10.0) | 35 | 200 | 9.8 | 9.8 | | | |
| 12-10 | 3.7 (14) | 145 (10.0) | 35 | 200 | 9.8 | 8.2 | | | |
| 13,7-16 | 4.0 (16) | 232 (16.0) | 144 | 200 | 11.5 | 8.2 | | | |
| 14-10 | 4.5 (17) | 145 (10.0) | 75 | 400 | 13.1 | 13.1 | | | |
| 16-10 | 5.0 (19) | 145 (10.0) | 144 | 200 | 11.5 | 8.2 | | | |
| 17-4 | 5.3 (20) | 58 (4.0) | 35 | 200 | 3.3 | 3.3 | | | |
| 18-10 | 5.8 (22) | 145 (10.0) | 75 | 200 | 9.8 | 9.8 | | | |
| 25-3 | 7.9 (30) | 44 (3.0) | 35 | 200 | 3.3 | 3.3 | | | |
| 26-10 | 8.2 (31) | 145 (10.0) | 75 | 200 | 9.8 | 8.2 | | | |
| 27-10 | 8.4 (32) | 145 (10.0) | 144 | 200 | 11.5 | 8.2 | | | |
| 35-10 | 11.0 (42) | 145 (10.0) | 144 | 100 | 8.2 | 6.5 | | | |
| 39-4 | 12.0 (47) | 58 (4.0) | 75 | 100 | 3.3 | 3.3 | | | |
| 50-10 | 16.0 (60) | 116 (8.0) | 144 | 100 | 8.2 | 4.9 | | | |
| 60-3 | 19.0 (72) | 44 (3.0) | 75 | 100 | 3.3 | 3.3 | | | |
| 75-3,5 | 24.0 (90) | 51 (3.5) | 144 | 100 | 1.6 | 1.6 | | | |
| 115-3 | 36.0 (138) | 36 (2.5) | 144 | 100 | 1.6 | 1.6 | | | |

| DMX 226 Pump | Max capacity (Duplex x 2) | | SPM (at 60 Hz) | Max Viscosity* cps | Max suction lift* | | Motor voltage | Accuracy flow | Linearity |
|--------------|------------------------------|------------|-------------------|-----------------------|-------------------|----------|--|---------------|-----------|
| | GPH (l/hr) | psi (bar) | | | Primed (ft) | Dry (ft) | | | |
| 52-8 | 16.4 (62) | 116 (8.0) | 76 | 700 | 8.2 | 3.2 | DMX-B: no motor, Nema 56 C flange DMX-AR: 1∅115V, 60 Hz | +/- 1.5% | +/- 4% |
| 67-10 | 21.1 (80) | 145 (10.0) | 68 | 700 | 8.2 | 3.2 | | | |
| 82-5 | 25.9 (98) | 72 (5.0) | 76 | 500 | 8.2 | 3.2 | | | |
| 95-8 | 30.0 (114) | 116 (8.0) | 68 | 500 | 8.2 | 3.2 | | | |
| 100-8 | 31.7 (120) | 116 (8.0) | 144 | 400 | 8.2 | 3.2 | | | |
| 130-3 | 41.2 (156) | 44 (3.0) | 76 | 400 | 6.6 | 3.2 | | | |
| 132-10 | 41.7 (158) | 116 (8.0) | 144 | 400 | 8.2 | 3.2 | | | |
| 152-6 | 48.0 (182) | 87 (6.0) | 68 | 400 | 6.6 | 3.2 | | | |
| 160-5 | 50.7 (192) | 72 (5.0) | 144 | 200 | 8.2 | 3.2 | | | |
| 199-8 | 63.1 (239) | 116 (8.0) | 144 | 200 | 8.2 | 3.2 | | | |
| 249-3 | 78.9 (299) | 44 (3.0) | 68 | 100 | 3.2 | 1.6 | | | |
| 255-3 | 80.8 (306) | 44 (3.0) | 144 | 100 | 6.6 | 3.2 | | | |
| 321-6 | 102.0 (385) | 58 (4.0) | 144 | 100 | 6.6 | 3.2 | | | |
| 525-3 | 166.3 (630) | 44 (3.0) | 144 | 50 | 3.2 | 1.6 | | | |

*Note: Suction lift data is for water-like fluids. Please see the pump manual for more details and dimensional data.

DMH – Performance-Ready from 0.07 to 2 x 278 gph (1052 l/h)



Robust Design

The Grundfos DMH range is a series of hydraulic pumps for situations that demand a higher quality pump. With its high accuracy and modern interface possibilities, the DMH is ideal for many applications in water treatment and industrial processing.

Prepared for Performance and Safety in Extreme Situations

The DMH 250 series of pumps is available in PVC, PVDF, polypropylene, stainless steel and Hastelloy C wetted components. For higher pressure requirements, select from the series of stainless steel or Hastelloy C DMH 280 pumps, rated up to 2900 PSI. All models are fitted with a PTFE diaphragm, with the AMS diaphragm protection system and internal relief valve for pump protection.

Get the Pump Configuration You Need

Manually control capacity by adjusting the stroke length from 0 to 100% with +/- 1% repeatable accuracy. Additional options include:

- Duplex version for doubled capacity or blending applications
- Electric 4-20 mA servomotor or pneumatic stroke length control
- Variable speed drive controller
- Integrated stroke sensor and electronic counter
- Leak detection

Typical Applications

- Municipal and industrial water treatment
- Wastewater treatment
- Chemical industry
- Boiler feed
- Petroleum industry
- Filtration systems
- pH control
- Demineralizers
- Pulp & paper
- Textile
- Food & beverage

API 675 Models

DMH 250 and 280 series pumps are available in API 675 compatible versions. This is commonly used in petroleum, chemical refineries, and transmission pipeline applications.



DMH 250 Technical Specifications

| DMH 250 Series Pump | Max capacity | | SPM (at 60 HZ) | Max Viscosity* cps | Max suction lift ft | |
|---------------------|--------------|-------|----------------|--------------------|---------------------|-----------|
| | GPH | PSI | | | | |
| 251 | 2,2-25 | 0.69 | 363 | 17 | 300 | 3.3 |
| | 2,3-16 | 0.74 | 232 | 17 | | |
| | 2,4-10 | 0.77 | 145 | 17 | | |
| | 4,5-25 | 1.43 | 363 | 35 | | |
| | 4,9-16 | 1.55 | 232 | 35 | | |
| | 5,0-10 | 1.58 | 145 | 35 | | |
| | 11-25 | 3.43 | 363 | 75 | 100 | - |
| | 12-16 | 3.7 | 232 | 75 | | |
| | 13-10 | 4.22 | 145 | 75 | | |
| | 17-25 | 5.28 | 363 | 115 | | |
| | 18-16 | 5.81 | 232 | 115 | | |
| 19-10 | 6.07 | 145 | 115 | | | |
| 252 | 10-16 | 3.17 | 232 | 35 | 300 | 3.3 |
| | 11-10 | 3.45 | 145 | 35 | | |
| | 23-16 | 7.13 | 232 | 75 | 100 | |
| | 24-10 | 7.66 | 145 | 75 | | |
| | 36-16 | 11.35 | 232 | 115 | | |
| | 37-10 | 11.62 | 145 | 115 | | |
| 253 | 21-10 | 6.6 | 145 | 35 | 300 | 3.3 |
| | 43-10 | 13.7 | 145 | 75 | 100 | |
| | 67-10 | 20.6 | 145 | 115 | | |
| | 83-10 | 26.1 | 145 | 144 | 10 | |
| 254 | 50-10 | 15.8 | 145 | 32 | 300 | 3.3 |
| | 97-16 | 30.6 | 232 | 65 | 100 | |
| | 102-10 | 32.2 | 145 | 65 | | |
| | 136-16 | 43 | 232 | 90 | | |
| | 143-10 | 45.4 | 145 | 90 | | |
| | 166-16 | 52.8 | 232 | 110 | | |
| | 175-10 | 55.4 | 145 | 110 | | |
| | 202-16 | 63.9 | 232 | 134 | | |
| 213-10 | 67.3 | 145 | 134 | | | |
| 255 | 194-10 | 61.5 | 145 | 65 | 200 | Flooded** |
| | 270-10 | 85.5 | 145 | 90 | | |
| | 332-10 | 105 | 145 | 110 | 5 | |
| | 403-10 | 128 | 145 | 134 | | |
| 257 | 220-10 | 69.7 | 145 | 33 | 200 | 3.3 |
| | 440-10 | 139.4 | 145 | 65 | | |
| | 575-10 | 182.2 | 145 | 90 | | |
| | 770-10 | 244 | 145 | 110 | | |
| | 880-10 | 278 | 145 | 134 | 5 | Flooded** |

DMH 280 Technical Specifications

| DMH 280 Series Pump | Max capacity | | SPM (at 60 HZ) | Max Viscosity* cps | Max suction lift ft | |
|---------------------|--------------|------|----------------|--------------------|---------------------|-----------|
| | GPH | PSI | | | | |
| 280 | 1,3-200 | 0.5 | 2900 | 76 | 5 | Flooded** |
| | 2,2-200 | 0.7 | 2900 | 115 | | |
| | 2,5-200 | 0.9 | 2900 | 144 | | |
| 281 | 2-100 | 0.6 | 1450 | 35 | 100 | 3.3 |
| | 4,2-100 | 1.3 | 1450 | 76 | 50 | |
| | 6,4-100 | 2 | 1450 | 115 | 50 | |
| | 8-100 | 2.5 | 1450 | 144 | 5 | |
| 283 | 19-100 | 6.1 | 1450 | 65 | 50 | 3.3 |
| | 27-100 | 8.4 | 1450 | 90 | | |
| | 33-100 | 10.6 | 1450 | 110 | | |
| | 40-100 | 12.7 | 1450 | 134 | 5 | |
| 285 | 20-100 | 6.3 | 1450 | 33 | 100 | 3.3 |
| | 40-100 | 12.7 | 1450 | 67 | 50 | |
| | 52-100 | 16.6 | 1450 | 88 | | |
| | 70-100 | 22.2 | 1450 | 118 | | |
| | 80-100 | 25.3 | 1450 | 134 | 5 | |
| 286 | 85-50 | 26.9 | 725 | 67 | 50 | 3.3 |
| | 111-50 | 35.1 | 725 | 88 | | |
| | 170-50 | 53.9 | 725 | 134 | 5 | |
| 287 | 18-200 | 5.8 | 2900 | 67 | 50 | 3.3 |
| | 23-200 | 7.4 | 2900 | 88 | | |
| | 31-200 | 9.8 | 2900 | 118 | | |
| | 36-200 | 11.4 | 2900 | 134 | 5 | |
| 288 | 7.5-200 | 2.4 | 2900 | 67 | 50 | 3.3 |
| | 10-200 | 3.3 | 2900 | 88 | | |
| | 13-200 | 4.1 | 2900 | 118 | | |
| | 15-200 | 4.9 | 2900 | 134 | 5 | |

*Viscosity rating at 60Hz maximum SPM

**Flooded suction recommended

The stated valves are approximate and apply to standard pumps

Motor DMH B- NEMA 56C: 251,252,253,254,255,280,281,283,288
NEMA 145TC: 257,285,286,287
DMH AR - 1Ø115V, 60 HZ
DMH AR - Models 251, 252, 253, 280, 281 only

Accuracy Flow +/- 1%
Linearity +/- 2%

Dosing Station and Skid Systems



Dosing Tank Station

Designed for storing and dosing liquid chemicals and has easy installation and setup.



Dosing Skid System

Our systems are designed to make it's dosing technology available as a total package - with the same level of quality and reliability you expect and have come to depend on from Grundfos. Systems are available for all Grundfos dosing pumps including the state-of-the-art digital dosing pump with 1000:1 turndown capability.

Accessories



Rigid Suction Line

Preassembled, adjustable-length rigid suction line consists of a foot valve with strainer, rigid suction pipe, threaded tank connection and suction tubing. Also available with dual-level control sensors.



External Dosing Monitor

The dosing monitor is designed to monitor the dosing of liquids which may cause gas accumulation in the dosing head, thus stopping the dosing process even if the pump is still operating.

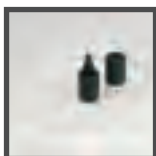

Installation Kit

A basic installation kit consists of a non-return foot valve equipped with a strainer and weight, a spring-loaded non-return injection valve and the requisite tubing.



Multifunction Valve

This compact valve unit is mounted directly on the pump discharge connection. Its four functions are:

- Constant back pressure
- Protects pump against excessive pressure
- Anti-siphoning
- Manual pressure relief of pump and discharge line



Back Pressure and Relief Valve

Installed in-line, the valve works as a back pressure valve optimizing dosing accuracy into systems with fluctuating pressure, or as an anti-siphoning valve in non-pressurised systems. Installed in a T-connection, the valve works as a pressure relief valve or a safety valve, protecting the pump and discharge line against excessive pressure. The valve is adjustable between 0 and 145 psi (10 bar).

Disinfection and Instrumentation

| DISINFECTANT | CHLORINE GAS | | | | CHLORINE DIOXIDE | | | |
|---------------------|----------------------------|-------------------------|-------------------------------|--|------------------------------------|------------------------------------|------------------------------------|------------------------------------|
| METHOD / COMPONENTS | chlorine gas dosing (HClO) | | | Salt (NaCl) | HCl / NaClO ₂ diluted | | concentrated | chlorine/NaClO ₂ |
| PRODUCTS | Vaccuperm VGA-111 | Vaccuperm VGA-117 | Vaccuperm VGS-140 | Selcoperm SES | Oxiperm OCD-162 | Oxiperm OCD-164 | Oxiperm OCC-164 | Oxiperm OCG-166 |
| CAPACITY | up to 4 kg/h (8.8 lb/h) | up to 10 kg/h (22 lb/h) | up to 200 kg/h (440 lb/h) | up to 2000g/h (4.5 lb/h) | up to 60 g/h (0.13 lb/h) | up to 2000 g/h (4.4 lb/h) | up to 2500 g/h (5.5 lb/h) | up to 10 kg/h (22 lb/h) |
| SPECIAL FEATURES | full vacuum systems | full vacuum systems | automated full vacuum systems | electrolytic Cl ₂ generator | on site ClO ₂ generator | on site ClO ₂ generator | on site ClO ₂ generator | on site ClO ₂ generator |
| IMAGES | | | | | | | | |

Measurement and control

Choose from a complete range of easy-to-use amplifiers for measurement and control in a wide range of disinfection applications. In addition we offer a full line of analyzers that can measure one or two different parameters; compensate for pH, temperature or flow variations and provide you with a PID-controlled analog output.

DIA-1, DIA-2, DIA-2Q and DIP

Conex DIA-2Q



Dual measuring amplifier and multi-functional controller allows for compound loop control with flow compensation.

Monitoring and control parameters:

Parameter 1: Chlorine, chlorine dioxide, ozone, hydrogen peroxide or peracetic acid
Parameter 2: pH, redox or fluoride



The preassembled units from Grundfos are delivered with an amplifier and controller and your choice of measuring cell and cleaning method

Conex DIA-1



Universal measuring amplifier and controller

Monitoring and control parameters:

Chlorine, chlorine dioxide, ozone, hydrogen peroxide, peracetic acid, pH, redox or fluoride

